

STUDY ON THE DEVELOPMENT OF MULTI-PURPOSE CANALSIDE TRANSHIPMENT PLATFORMS IN THE BRUSSELS REGION

FINAL REPORT



Contracting authority:

Port of Brussels

Contact person: Xavier Thirionet

+32 (0)2 421 66 29 - xthirionet@haven.irisnet.be

Date:

October 3, 2013

Title	Study on the development of multi-purpose canalside transhipment platforms in the Brussels Region
Contracting authority	Port of Brussels Contact person: Xavier Thirionet +32 (0)2 421 66 29 - xthirionet@haven.irisnet.be
Engineering company	Technum (Tractebel Engineering s.a.) Avenue Ariane 7, 1200 Brussels Contact person: Mathieu Nicaise +32 2 773 78 02 - mathieu.nicaise@technum-tractebel.be
Date	October 3, 2013
Revision	/

QUALITY



DOCUMENT HISTORY (THE TOP ROW IS THE CURRENT VERSION)

Version	Date	Comments
1	07/08/2013	
2	03/10/2013	Translation in English

PERSONS RESPONSIBLE FOR THE DOCUMENT

Author(s)	Cathy Boone Olivier Choveau Dries Goffin Mathieu Nicaise Vinciane Wauteurs	Date 31/07/2013
Document reviewer(s)	Mathieu Nicaise	Date 07/08/2013 03/10/2013

FILE INFORMATION

File name	131003_Final Report_EN
Last saved	04/10/2013

CONTENTS

- 1. Introduction _____ - 1 -**
 - 1.1 Background to the assignment _____ - 1 -
 - 1.2 Objectives of the assignment _____ - 1 -

- 2. Phase 1 – Identification of needs _____ 3**
 - 2.1 Objective of Phase 1 _____ 3
 - 2.2 Phase 1.1: Benchmarking _____ 3
 - 2.2.1 Literature review of projects3
 - 2.2.2 Discussions with port representatives and site visits7
 - 2.2.3 Benchmarking: evaluation and summary.....13
 - 2.3 Phase 1.2: Interviews with potential users_____14
 - 2.3.1 Ship operator14
 - 2.3.2 Potential clients.....15
 - 2.4 Phase 1.3: Requirements _____15
 - 2.4.1 Analysis of existing data15
 - 2.4.2 Identification of the needs – potential users.....16
 - 2.4.3 Conclusion Phase 1.3.....17

- 3. Phase 2 – Determination of the superstructures and infrastructure works _____ 19**
 - 3.1 Phase 2.1: Identification of the sites constraints _____19
 - 3.1.1 Technical review19
 - 3.1.2 Boundary conditions26
 - 3.1.3 Feasibility of the logistic concept33
 - 3.1.4 Conclusions - allowable loads behind quay wall46
 - 3.1.5 Strengthening proposal.....47
 - 3.2 Phase 2.2: Logistics concepts that meet needs _____59
 - 3.2.1 Introduction.....59
 - 3.2.2 Alternative methods for storing packages59
 - 3.2.3 Storage capacity60
 - 3.2.4 Determining the storage capacity62
 - 3.2.5 Use of the storage space62
 - 3.3 Phase 2.3: Determining the equipment and infrastructure required _____63
 - 3.3.1 Loading/unloading crane.....63
 - 3.3.2 Industrial lift trucks67
 - 3.3.3 Reach stacker68
 - 3.3.4 Weighing platform.....69

3.3.5	Models for different types of trolley, according to the product being handled	69
3.3.6	Logistics operators	70
3.3.7	Proposed equipment for the Biestebroek platform	71
3.3.8	Proposed equipment for the Vergote platform.....	72
3.3.9	Budget estimate for the main handling equipment.....	72
4.	Phase 3 - Connecting the Vergote platform to the TIR centre	74
4.1	Background and objectives	74
4.2	Possible solutions	74
4.3	Choosing the best solution	75
5.	Phase 4 – Layout, operational and traffic plans	77
5.1	Summary of the operational programme	77
5.2	Biestebroek	77
5.3	Vergote	78
5.4	Other work and equipment	79
5.5	Evaluation of operational performance	80
5.5.1	Transfer time (entry/exit)	80
5.5.2	Goods storage and waiting time	80
5.5.3	Resources per unit of goods processed and handled.....	81
5.6	Study of impact on mobility	81
5.6.1	Flows generated by the platform’s activities	81
5.6.2	Biestebroek platform.....	81
5.6.3	Vergote platform	83
6.	Conclusion	86
7.	BibliographY	87
8.	Annex	88

1. INTRODUCTION

1.1 Background to the assignment

The Port of Brussels is a public interest organisation whose majority shareholder is the Brussels-Capital Region. It is tasked with managing, operating and developing the canal and port sites in the Brussels-Capital Region (key statistics: 14 km of waterway, 12 km of quays and wharves, traffic of 7 million tons per year, superficies of 85 Ha, 360 concession-holding companies, around 12,000 direct and indirect jobs).

One of the main tasks of the Port of Brussels is to promote use of the waterway to supply the Brussels-Capital Region and remove the goods produced or consumed there. In this connection, and as set out in its recently finalized Master Plan to 2030, the Port of Brussels aims to strengthen its role as a 'logistics facilitator' in supplying the region by establishing a network of transshipment points and platforms to accommodate city distribution activities.

The network would consist of two types of platforms:

- 'Hubs' (one in the Vergote dock and one in the Biestebroeck dock), covering between 2,000 and 3,000 m² and providing a base for additional logistics activities prior to dispatch;
- Local transshipment points ('spots') between the hubs, used for unloading goods for immediate dispatch (tricycles, swap bodies, etc.) to their final destination.

This scheme is part of a European project (Connecting Citizen Ports 21) being undertaken by the Port of Brussels with six other European inland ports, including the Port of Paris and the Utrecht port authority, where city distribution projects have already been implemented.

1.2 Objectives of the assignment

The assignment relates to a design study for the two large platforms (hubs) in the Vergote and Biestebroeck docks. The aim is to determine the structures that need to be included on the platforms, their ideal configuration (taking into account the limited space available, the range of goods transhipped and the urban setting) and a plan for how they will operate (factoring in their use by multiple clients).

In accordance with the specifications, the study must do the following for each of the two platforms:

- Identify the different areas of activity (transshipment, storage, related logistics activities) and the relationship between them;
- Identify the superstructures (racks, covered areas, buildings, etc.);
- Identify the infrastructure works to be carried out according to the types of goods expected;

- Propose an overall development plan for each platform and an operational plan (bearing in mind that the platform will have multiple users) including a traffic plan and recommendations for ensuring the security of the site and goods, factoring in interactions with the neighbouring concession-holder, which is expected to use the platform and the connection with the TIR (International Road Transport) centre.

For the Vergote dock platform, an optimal solution must also be proposed for crossing Avenue du Port in order to connect the platform with the TIR centre.

The assignment consists of the following four phases:

- Phase 1:
 - Analysis of similar solutions developed by other inland ports;
 - Identification of the main actors who will use the platforms, the types and volumes of goods that they will transport and the logistics services that they would like to be provided.
- Phase 2:
 - Identification of the superstructures to be included on each platform and the prior infrastructure works.
- Phase 3:
 - Identification of the optimum solution for connecting the platform to the TIR centre.
- Phase 4:
 - Layout, operational and traffic plans.

2. PHASE 1 – IDENTIFICATION OF NEEDS

2.1 Objective of Phase 1

The aim of Phase 1 is to identify the needs of future users in order to come up with a coherent design for the transshipment platforms which meets user expectations. To achieve this, we are using two methods:

- Phase 1.1: analysis of best practices by means of a benchmarking exercise (literature research, contacts, site visits, etc.);
- Phase 1.2: meeting potential users.

The aim of Phase 1 is not therefore to study the economic suitability of the proposed concept. The Port of Brussels believes that this will become evident in the near future: rising transport costs, increasing road congestion around Brussels and (incentivising and dissuasive) measures taken by the authorities are all factors which will make new supply strategies economically viable.

2.2 Phase 1.1: Benchmarking

A generic benchmarking exercise was conducted as part of this study with the aim of identifying best practices in terms of the use of multi-purpose transshipment platforms for city distribution.

2.2.1 Literature review of projects

2.2.1.1 Introduction

Although there are now quite a number of waterway-based city distribution projects in Europe, these mostly involve the distribution of small volumes (packages, parcels) not requiring much transshipment infrastructure. These projects are more comparable with phase 2 of the Port of Brussels project, i.e. waterway-based city distribution projects from and between the two main platforms (Vergote and Biestebroeck). Projects relatively similar to the Brussels phase 1 project (creation of two waterside transshipment platforms for large volumes in an urban setting) are relatively rare.

Although phase 2 of the project is not included in this study, the following list sets out examples of waterway-based city distribution projects in Europe, for both small and large volumes. We have only included projects that are already up and running as the aim is to identify success and failure factors, which are not generally known for projects that are still in the design phase. That is why Antwerp's Blue Gate project, for example, is not included in the list.

Key data for each project is given below.

2.2.1.2 Project summaries

a) Vert Chez Vous

- Location: Paris
- Goods transported: Packages under 30 kg
- Customers: Businesses and individuals in central Paris (within 3 km of the Seine)
- Logistical organisation: Pre-carriage by road. The river barge (an upgraded Freyssinet with crane) is loaded in the port of Tolbiac. The barge contains tricycles which make the deliveries ('last mile') in central Paris (from four local unloading points). Part of the package sorting process and the tricycle loading takes place on board the barge during its journey.
- Launched in: May 2012
- Quayside equipment: Lightweight transshipment pod in the port of Tolbiac. No infrastructure at the unloading sites. The boat is equipped with a lightweight crane for unloading the delivery tricycles.
- More information (in French): <http://vertchezvous.com/>



Figure 1: "vert chez vous" barge on the Seine in Paris (source: vert chez vous)

b) DHL Express Amsterdam

- Location: Amsterdam
- Goods transported: Parcels, letters
- Customers: Shippers and recipients of mail-order goods (in central Amsterdam)
- Logistical organisation: Pre-carriage by road. The boat is loaded at a wharf outside the city centre. The boat contains mountain bikes which make the deliveries ('last mile') in central Amsterdam.
- Launched in: 1997
- Quayside equipment: /

There is a similar service in Venice (the packet gondola, which has been operating since the 1990s).

c) Bierboot

- Location: Utrecht
- Goods transported: Beer barrels and crates + fresh and frozen products
- Customers: Businesses (cafés and restaurants) in Utrecht city centre (mainly along the Oude Gracht).
- Logistical organisation: Preliminary carriage by road. The boat is loaded at a wharf outside the city centre. Deliveries are made directly to customers (all located on the waterside).
- Launched in: 1996
- Quayside equipment: No quayside infrastructure, but the boat is equipped with a crane.

d) Berlin U5 Bauhafen

- Location: Berlin
- Goods transported: Rubble and construction materials from works to extend the U5 metro line.
- Customers: The City of Berlin, which commissioned the work to create a new metro line.
- Logistical organisation: Rubble loaded at the construction site + construction materials delivered to the site.
- Launched in: 2012

- Quayside equipment: Construction of a new quay 80 m long and 9 m wide near to the construction site in the city centre. Cost of the work: €1 million. The facility is not intended to remain in use after completion of the metro project.

e) Franprix

- Location: Paris
- Goods transported: Non-perishable supermarket produce
- Customers: Franprix stores in central Paris
- Logistical organisation: Container barge between a Franprix platform (outside Paris) and the city centre (approx. 25 km). Containers loaded onto trucks in the centre of Paris. Local distribution by truck.
- Launched in: 2012
- Quayside equipment: Reinforced quay (mooring dolphins, local paving) costing around €1.5 million. A reach stacker is used to load/unload the containers. The containers have been custom-developed for the project.
- More information (in French):
<http://www.franprix.fr/franprix-entre-en-seine/accueil.html>

f) Mokum Mariteam

- Location: Amsterdam
- Goods transported: Construction materials, waste containers, roll containers
- Customers: Hotel/restaurant/catering businesses, building sites
- Logistical organisation: Pre-carriage by road or direct loading at sorting centre. The barges take the goods on the last or first kilometre of their journey in central Amsterdam (for customers located on the waterside). The barge contains an electric vehicle which can make deliveries where necessary (last 200 meters) in central Amsterdam, for customers not located on the waterside.
- Launched in: 2010
- Quayside equipment: No quayside infrastructure, but the barge is equipped with a crane.

2.2.1.3 Evaluation of projects

The first three projects (Vert Chez Vous, DHL Express and Bierboot) are examples of local distribution by waterway of small volumes of goods. They are not really relevant for our two-transshipment-platform project (although they are relevant for phase 2 of the Brussels project, i.e. local distribution by waterway from and between the two platforms). The other projects are more relevant for this study and are therefore examined in greater detail below.

2.2.2 Discussions with port representatives and site visits

The Franprix scheme in Paris and the Berlin case study are not relevant for the Brussels project from an economic or logistics concept viewpoint but they are relevant from a technical perspective. In both cases, a quay was built/strengthened to enable the transshipment of fairly heavy volumes of goods, as is planned in Brussels (transshipment of construction materials and/or containers).

Conversely, the Mokum Mariteam scheme corresponds slightly more to the Brussels project from the economic and logistics concept viewpoint but less so from a technical perspective (no construction/strengthening of quays).

The three projects are described and illustrated below. For the Paris and Berlin projects, only a description and photographs of the project are given as the economic aspects are not comparable with the Brussels project. With the Mokum Mariteam project, success and failure factors are also identified.

a) Franprix

The Franprix scheme is not especially comparable with the Brussels project from an economic viewpoint as it was initiated by a single company which is its sole client/beneficiary¹. The entire project was custom-developed to meet the needs of that company. Consequently, the scheme is of limited use to our study in this area.

That said, one of the project's success factors is of relevance to Brussels and that is the media impact of the project's launch. This was undoubtedly very valuable from a marketing point of view, with the slogan *Franprix entre en Seine* widely relayed in the media. Similarly, the custom-designed containers are plastered with advertisements promoting the benefits of the scheme and Franprix's commitment to reducing road traffic ("this container has driven up the Seine"). The scheme's logo is also displayed at the stores supplied by the network. In this sense, the project is just as much about public relations as it is about logistical optimisation.

The project is also very interesting from a technical perspective (reinforcing of a historic quay wall), and the lessons learnt from it have been incorporated into our proposals for the design of the Biestebroeck and Vergote platforms (see 3.1.5.1.3, 3.1.5.2 and 3.1.5.3).

¹ The haulier Norbert Dentressangle is only a service provider for this project.



Figure 2: Diagram of Franprix's river delivery scheme (source: Franprix)



Figure 3: The Franprix platform (Quai du Bourdonnais, Paris) (source: Technum)



Figure 4: Containers being transhipped using a reach stacker (source: Franprix)



Figure 5: Final deliveries in central Paris (source: Franprix)

b) Berlin U5 Bauhafen

From a conceptual point of view, the Berlin project bears little resemblance to the Brussels context either. The local government commissioned the construction of the quay in the centre of Berlin, on the River Spree, and required the contractors working on the large U5 metro line construction project to use the quay. This requirement undoubtedly accounts for the project's success.

Although the location of the new quay would enable it to be used for city distribution of consumer goods in the future (after completion of the six-year construction project), there are currently no specific plans to do this. The logistics of waterway transport are not expected to be competitive in relation to road transport, mainly because there is currently little road traffic congestion in Berlin and the dimensions and capacity of the Spree are limited.

As in Paris, the use of river transport was heavily emphasised in the PR surrounding the project.



Figure 6: *The new quayside on the River Spree, in the historic heart of Berlin (source: Technum)*



Figure 7: *View from the other end of the platform (source: Technum)*



Figure 8: Detail of the construction (source: Technum)



Figure 9: Information boards around the edge of the construction site, explaining the benefits of the scheme (source: Technum)

c) Mokum Mariteam

Mokum Mariteam is an example of large-scale city distribution by waterway. It is an operator which offers its services to multiple customers for the transportation of different types of goods. It is a multi-client, multi-service concept that is particularly well suited to the Amsterdam context. It uses a new boat (the *City Supplier*), purpose-built to meet the project's needs.

Success factors include:

- coercive legislation drastically limiting road transport in the city (Amsterdam has environmental zones where certain types of trucks are not permitted);
- the 'last mile' is short (in other words, customers must be located on or near the waterside);
- the boat is multi-purpose (autonomous crane vessel capable of loading different types of containers);
- there is high customer density, meaning that it is easy to find return cargo;
- costs are limited thanks to the use of existing infrastructure (e.g. Mokum Mariteam did not need to invest in quays, only its new crane vessel).

=> It is therefore a well-thought-out logistics concept, with unladen journeys kept to a minimum.



Figure 10: The City Supplier in the port of Amsterdam (source: Technum)



Figure 11: The City Supplier on one of the canals ('grachten') in Amsterdam city centre (source: Mokum Mariteam)



Figure 12: The City Supplier transhipping construction materials using its on-board crane (source: Mokum Mariteam)

2.2.3 Benchmarking: evaluation and summary

Relatively similar projects to the Brussels phase 1 project (creation of two waterside transshipment platforms for large volumes in an urban setting) are rare. Indeed, there is no existing project which is exactly comparable. Many projects involve city distribution by waterway, but pre-carriage is often by truck.

Nevertheless, the various case studies do allow us to pinpoint some critical success factors for developing profitable city distribution by water in Brussels:

- Coercive legislation that limits or eliminates the cost-effectiveness advantage of road transport over water or combined transport;
- Multi-purpose infrastructure (platform) and equipment (boat, crane);
- Using existing infrastructure wherever possible to limit transport/transshipment costs;
- A heavy focus on PR, and 'selling' the PR element to shippers as one of the major benefits of water transport.

2.3 Phase 1.2: Interviews with potential users

2.3.1 Ship operator

Interviews were realized with:

- Shipit ;
- JOGO shipping ;
- Blue Line.

Shipit would prefer to use bigger boats (class IV, with 500 pallets/ship) equipped with a mobile crane. However, the loading offer nowadays is often insufficient to fill up such boats.

The logistic concept of Shipit would be the supply of construction materials mainly to Vergote and to use Biestebroek as a satellite terminal (that can be reached with smaller ships). From Biestebroek, Shipit could organize transport of waste to the incinerator of Schaerbeek in separated presscontainers (return freight).

Container traffic to the 2 terminals would not be provided (according to Shipit there is already a container terminal nearby Vergote and Biestebroek is situated after two low bridges).

JOGO shipping is also more interested to use bigger boats (class IV, with 500 pallets/ship) and could show interested in the exploitation of the terminals.

Blue Line is developing "made to measure" small barges (180 pallets/ship) and he is also interested in the supply of the two terminals with two of his ships. These ships are equipped with "spud poles" which allows to deliver goods somewhere else in Brussels than in the terminals themselves.

Conclusion: It is important to have a bunch of clients in order to be able to fill up a ship. Therefore either ships should be rather small in a starting phase, or the flows have to be bundle (transport synergy). Also, one has to take into account that the surfaces of the terminals are not so big.

Minutes of meeting with ship operator are presented in Annex 6.

More details about the logistic concept of these 3 operators are reported at 3.3.6.

2.3.2 Potential clients

Four potential clients have been interviewed: building material dealer MPRO, beer company Inbev and 2 others building materials manufacturers. They have a preference for the use of smaller ships, as their flow of goods is quite limited.

Some opportunities have been identified with the logistic expert of the Port of Brussels:

- Supply to Brussels for construction manufacturers (like M-Pro) and eco-yards (construction sites with a green label) ;
- Possible return freight from Brussels with land residues that can be dumped (in existing grooves) ;
- Products with a high rotation percentage (as such no niche products) ;
- Transport by water will be more and more a competitive advantage. Certain clients ask this in the context of their "BREEAM" certification.

On the contrary, there is not much to expect from:

- Transport of big bags in fluvial transport (little volumes and not stackable) ;
- The beer warehouse in Anderlecht: volumes are too small to expect a modal shift under the current price conditions.

2.4 Phase 1.3: Requirements

2.4.1 Analysis of existing data

Data were collected through the study realized by the VUB (University of Brussels) and the potential clients that have been met.

2.4.1.1 Economic feasibility study of a modal shift of FMCG (Fast Moving Consumer Goods) on pallets to fluvial transport – VUB

The results of the study were presented by VUB on the 22 th of May 2013. The objectives of the study were to:

- Verify if there are enough volumes to justify a modal shift of the FMCG (electronics, sport material, beverages, ...);
- Evaluate a subsidy mechanism to attract more flows;
- Estimate the optimal locations of transshipment platforms along the canal.

26 companies have been interviewed and 13 of them have declared their interest in modal shift.

On the basis of the existence of 2 hubs (Biestebroeck and Vergote), in the base scenario only 8 flows are competitive by water transport. They represent 136.469 tons and/or pallets. In the scenario "direct link to the water", which means that the transshipment costs (charging and uncharging a lorry) and the pre or post transport are spared, 21 flows have been identified as being competitive by water compared to the road. This represents 145.744 tons or 148.918 pallets. Important to note is that these volumes can only exist if a network of hubs is installed in Belgium and abroad.

2.4.1.2 Potential customers

Concerning the traffic of construction materials:

- The market of construction materials on pallets (inside the Ring of Brussels) is evaluated at +/- 350.000 tons a year (estimation based on interview data) ;
- Considering that 1/3th can be transported by water (about 120.000 tons or 100.000 pallets) in ships of +/- 500 tons, it means 240 ships per year, i.e. one ship arriving per working day ;
- Also bigger ships could be considered (class III or IV) for such flows, which would result in a ship every two working days ;
- The flow must be divided between the two sites.

Concerning the traffic of FMCG (VUB study):

If we consider the base scenario of 136.469 tons/year, it means that we will have about 270 ships of 500 tons per year, which is also one ship per working day.

Concerning the traffic of beverages:

The flows from Jupille to Anderlecht are actually insufficient to shift to fluvial transport.

2.4.2 Identification of the needs – potential users

2.4.2.1 Selection of potential clients

Based on the interviews with the logistic expert of the Port of Brussels and the potential clients, following clients can be seen as a potential for inbound activities:

- Big construction sites supply (although just in time delivery is crucial for this activity);
- Wholesale businesses in construction materials: M-Pro, Wienerberger, Saint-Gobain, etc.;
- FMCG;
- Beverage: Inbev has a small depot in Anderlecht, nearby the 'Vaartdijk' (but little volumes).

Potentials in outbound activities are:

- Waste: residues from the incinerator, sorted products;
- FMCG;
- Sand in bags: DISTRIMACO (limited potential);
- Urban distribution from the "TIR" center.

A first sketch of potential clients' localization is shown on map 17 in the Annex.

2.4.2.2 Possible packaging

- Pallets of construction materials (undoubtedly the most important market segment);
 - Big bags (but rather limited);
 - Bundles (paper waste, etc.)/ boxes, carts, etc. (urban distribution);
 - Containers?
 - o North: proximity of existing container terminal;
 - o South: limited market and dependency on the bridge gauge;
 - o Volumes will be limited as is the available space on both terminals
- Important container transport to the terminals is unlikely (but it can be a "niche" market and a small container terminal at the south is important for the Port of Brussels, due to strategic reasons).

2.4.3 Conclusion Phase 1.3

Mainly cross-docking activities will be provided on the terminals. Stockpiling capacity isn't really necessary.

Transshipment of pallets will be the main activity, as important container transshipment will probably not be considered in a first stage, due to the existence of a container terminal nearby Vergote and the difficult access of Biestenbroeck (bridge gauge).

Smaller ships for the supply of goods must be foreseen in order to minimize empty transport and in order to be in proportion to the surface of the terminals.

The concept should be extended to a shuttle system on the "A-B-C" axe (Antwerp-Brussels-Charleroi). Therefore the elaboration of a good logistic concept is necessary (see Mokum Mariteam project in Amsterdam).

3. PHASE 2 – DETERMINATION OF THE SUPERSTRUCTURES AND INFRASTRUCTURE WORKS

3.1 Phase 2.1: Identification of the sites constraints

3.1.1 Technical review

Our analyze is based on drawings, visual inspection and divers research.

The quay walls are constructed quite a long time ago. The actual quality of the concrete is unknown. In case the concrete elements still fulfill a structural function, the actual strength of the concrete should be checked.

Only a few drawings are available of the existing quay walls. These drawings include the preliminary design properties of the quay walls. No as-built drawings are available.

3.1.1.1 Zone Biestebroeck Dock

3.1.1.1.1 Drawings

The quay wall in the Biestebroeck Dock exists of a concrete platform positioned on concrete piles. Above this platform a concrete block (width 1.2 m, height 2 m) is placed on dock side. The area behind this block is filled with soil. See Figure 13 hereafter.

Based on the available drawings, it is not clear whether the concrete block in front of the quay wall is reinforced or not and if the block is fixed to the platform. In all probability the block is not reinforced and fixed to the platform. This block will be verified as a gravity wall positioned on the platform.

The sheet pile wall consists of reinforced concrete slabs of 4.5 m high and a thickness of 15 cm. The reinforcement is unknown.

The piles also consists of reinforced concrete piles, positioned each 2.25 m a.o.a (axis on axis) along the quay wall. The reinforcement and length of the piles are unknown. Based on the drawing the lengths are estimated at 11 m.

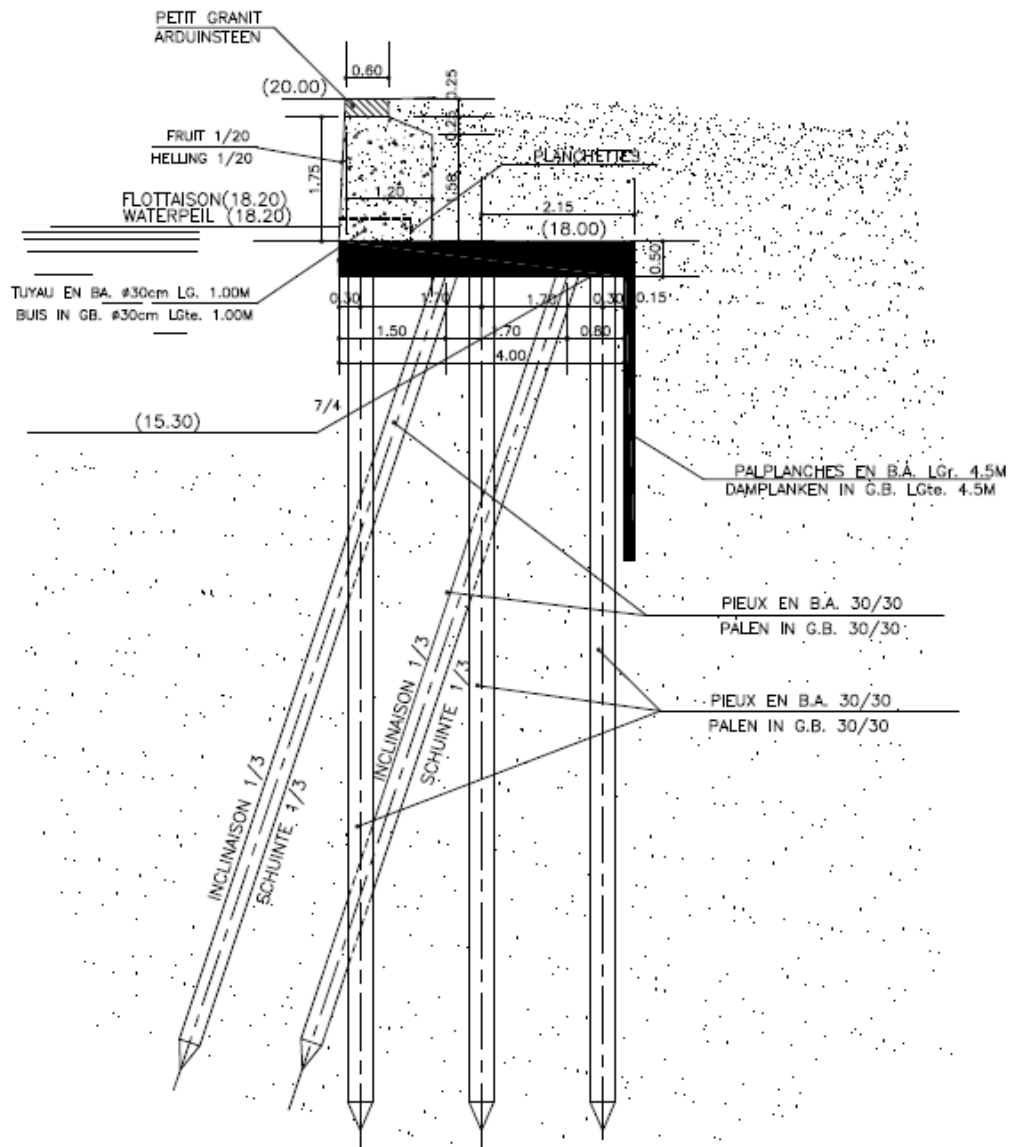

Figure 13: Cross section existing quay wall Biestebroek Dock (source: Port of Brussels)

3.1.1.1.2 Visual inspection

During visual inspection dd. 10/4/2013 following elements were found:

- The concrete surface is strongly eroded (see Figure 15);
- Two large cracks are found in the concrete upper structure (Figure 16 and Figure 17);
- Just below water level, a tube was visible (Figure 17);
- Behind the fenders a void was visible near the water level (Figure 18);
- Depth of water level near the quay wall was measured: 2.10 m;
- Erosion between granite block and concrete structure (Figure 19).

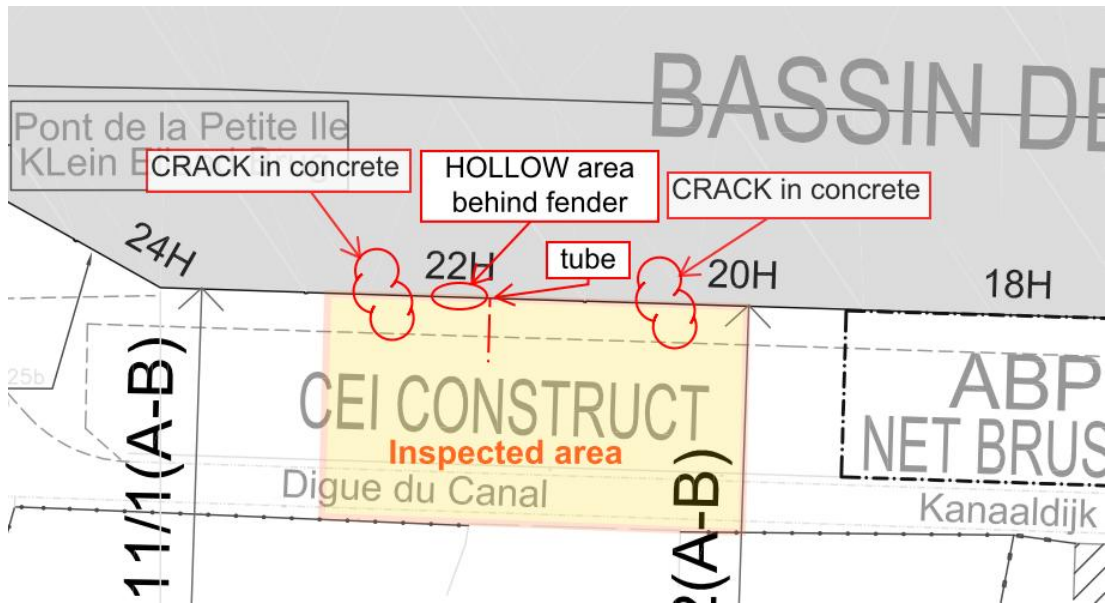

Figure 14: Visual inspection quay wall Biestebroeck Dock – visual inspection site (source: Technum)



Figure 15: Visual inspection quay wall Biestebroeck Dock – concrete erosion (source: Technum)



Figure 16: Visual inspection quay wall Biestebroeck Dock – crack in concrete near 20H
(source: Technum)



Figure 17: Visual inspection quay wall Biestebroeck Dock – crack and tube in concrete near 20H
(source: Technum)



Figure 18: Visual inspection quay wall Biestebroeck Dock – void between concrete structure and fender (source: Technum)



Figure 19: Visual inspection quay wall Biestebroeck Dock – erosion between granite and concrete (source: Technum)

3.1.1.1.3 Divers research

The actual state of the piles has been investigated by divers during our study. The dimensions of the piles have been checked: the piles have an area of 0.3 x 0.3 m and are installed at appr. 2 m distance a.o.a. This verifies the dimensions on the drawings.

The divers could only reach the first 1 m below the quay wall because the presence of mud. 40 piles positioned in front of the quay wall have been checked. Only 0.4 m to 1 m of visible pile length could be measured, while drawings indicate the visible pile length should be appr. 2 m.

On 1 pile, casing is found, although in bad condition, but no further damage to that pile.

All piles are still smooth without any signs of reinforcement, except for one pile where a reduced concrete cover is found.

3.1.1.2 Zone Vergote Dock

3.1.1.2.1 Drawings

The quay wall in the Vergote Dock exists of a concrete platform positioned on wooden piles. Above this platform a brick block is placed on dock side. The block has been implemented with buttresses. Thickness and distances between the buttresses are unknown. The area behind this block is filled with soil (height 3.3 m). See Figure 20.

Based on the available drawings, it is not clear whether the brick block in front of the quay wall is fixed to the platform or not. In all probability the block is not fixed to the platform. This block will be verified as a gravity wall positioned on the platform.

The sheet pile wall in front of the quay wall has a length of 7.5 m and a thickness of 15 cm. Material is unknown, probably concrete slabs. The sheet pile wall at the back of the quay wall consists of wooden slabs of 5 m high and a thickness of 8 cm.

The piles are made of wood, have a length of 10 m and are positioned each 1.25 m a.o.a. along the quay wall.

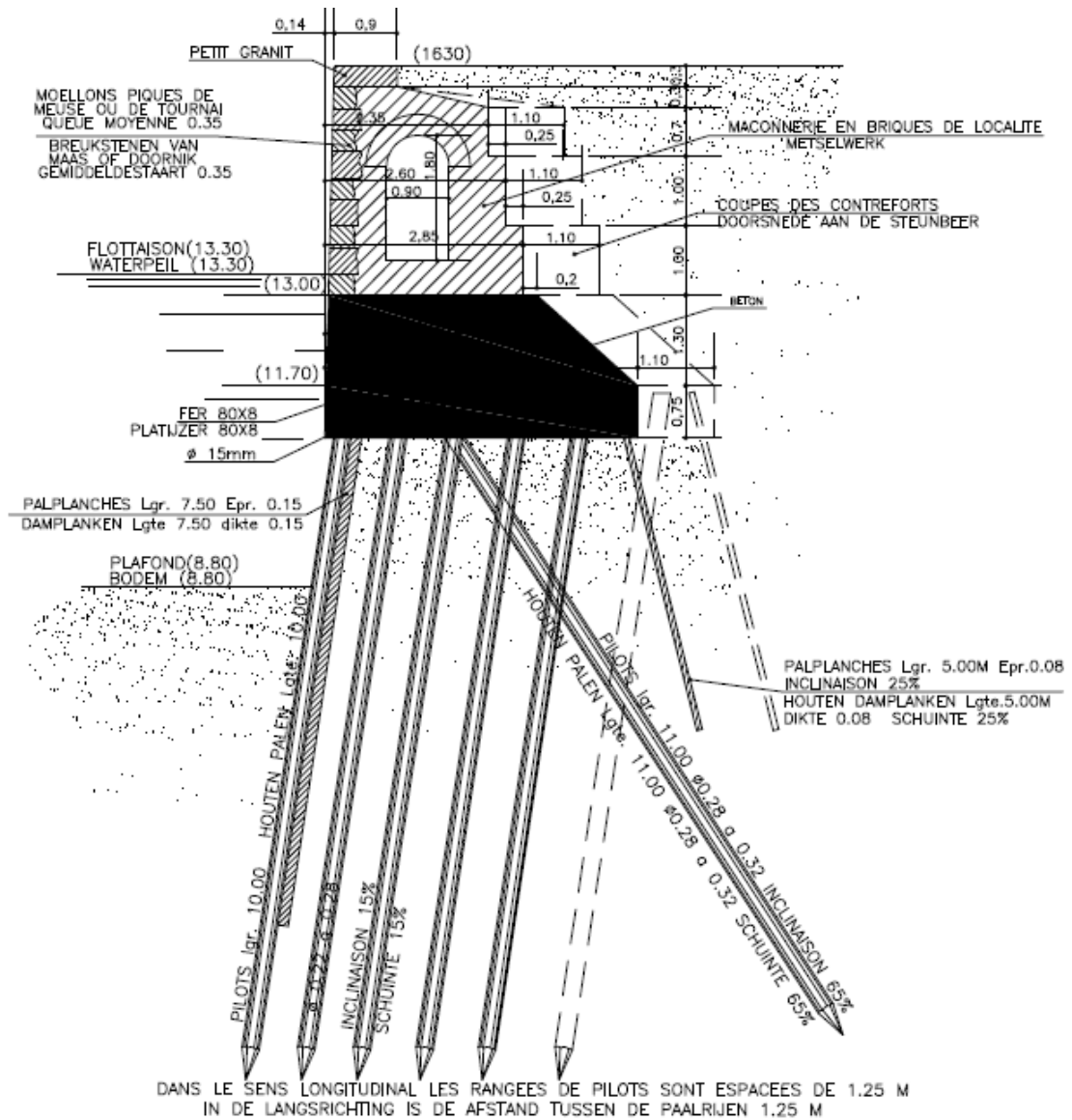

Figure 20: Cross section existing quay wall Vergote Dock (source : Port of Brussels)

3.1.1.2.2 Visual inspection

The visual inspection dd. 10/4/2013 showed that the quay wall was in much better condition than the one in Biestebroek Dock. Only a small hole was visible in the granite covering slab (see Figure 21).



Figure 21: Visual inspection quay wall Vergote Dock – void in granite covering block (source: Technum)

3.1.1.2.3 Divers research

Research of the actual status of the piles is impossible without any excavation of the terrain. The piles are positioned beneath water level and can therefore be expected to be in good condition.

3.1.2 Boundary conditions

3.1.2.1 Water table

3.1.2.1.1 Freatic water level

- Biestebroeck Dock: +19.00 m TAW
- Vergote Dock: +16.00 m TAW

3.1.2.2 Dock level

- Biestebroeck Dock: +18.20 m TAW
- Vergote Dock: +13.30 m TAW

3.1.2.3 Loads

3.1.2.3.1 Mobile loads

Most of the traffic at the 2 docks will be pallets and big bag. However, according to the Port of Brussels, container traffic has not to be excluded for strategic reasons, especially Biestebroeck platform. Both docks have as a result to be design to accommodate container handling and storage.

According to EAU 2004 crane loads for container handling of 60 kN/m^2 ($= 6 \text{ ton/m}^2$) should be taken into account inboard for a width of 2 m from the rear edge of the quay wall. Outside the waterfront cargo handling area following live loads should be taken as the basis in accordance with (Pianc, 1987):

- Empty container, stacked 4 high: 15 kN/m^2 ($=1,5 \text{ T/m}^2$)
- Full container, stacked 2 high: 35 kN/m^2 ($=3,5 \text{ T/m}^2$)
- Full container, stacked 4 high: 55 kN/m^2 ($=5,5 \text{ T/m}^2$)

Loads for pallet and big bag are less stringent (generally 20 to 40 KN/m^2).

For this study, a uniform mobile load of 60 kN/m^2 ($= 6 \text{ ton/m}^2$) will be considered for the whole quay area of the 2 docks. When not allowable, the maximum mobile load will be determined.

3.1.2.3.2 Bollard loads

The bollard loads depends on the type of ship. EAU prescribes a load of 200 kN for inland navigation.

The bollards in Biestebroek Dock are positioned each 50 m. In Vergote Dock they are positioned each 20 m.

3.1.2.4 Soil properties

3.1.2.4.1 Zone Biestebroek Dock

Soil properties are determined based on following CPTs (see Figure 22), made on the neighbourhood parcel:

- 1 CPT no 26 from Orex, dd. 4/11/1994
- 3 CPT's from SGS, dd.3/7/2013

The CPT carried out by Orex shows good agreement with CPT S2. S1 (both a and b) reached the maximum resistance at a depth of 0.60 m. The definition of the layers and their soil properties are given in Table 1 and Table 2.

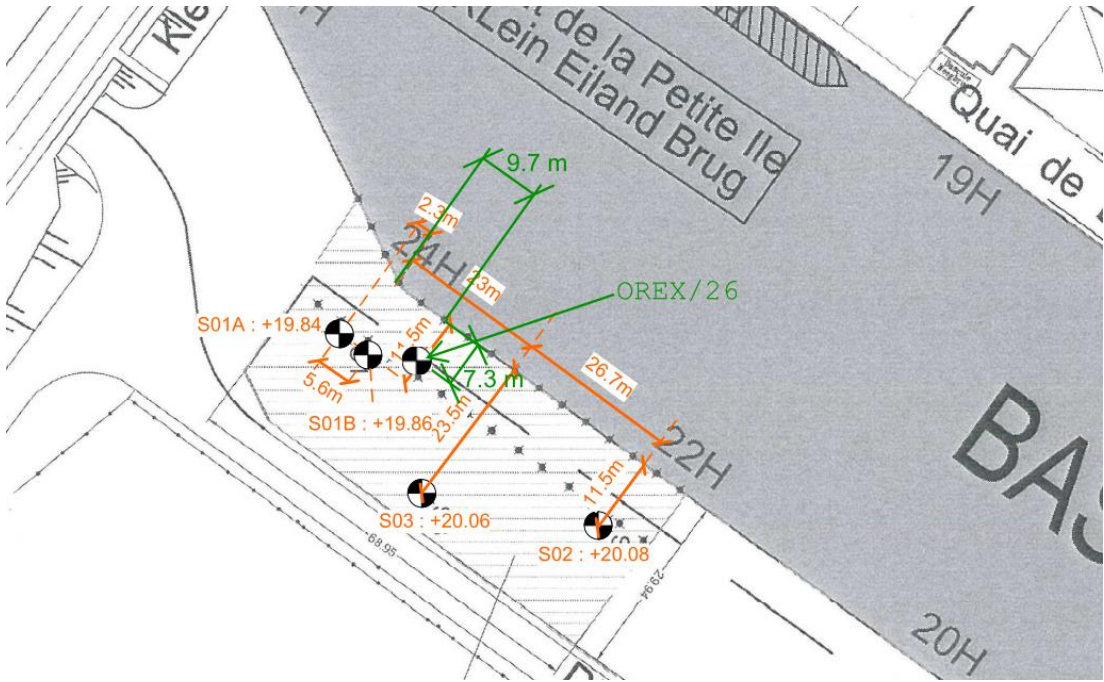

Figure 22: Location CPTs – Biestebroeck (source: Technum)

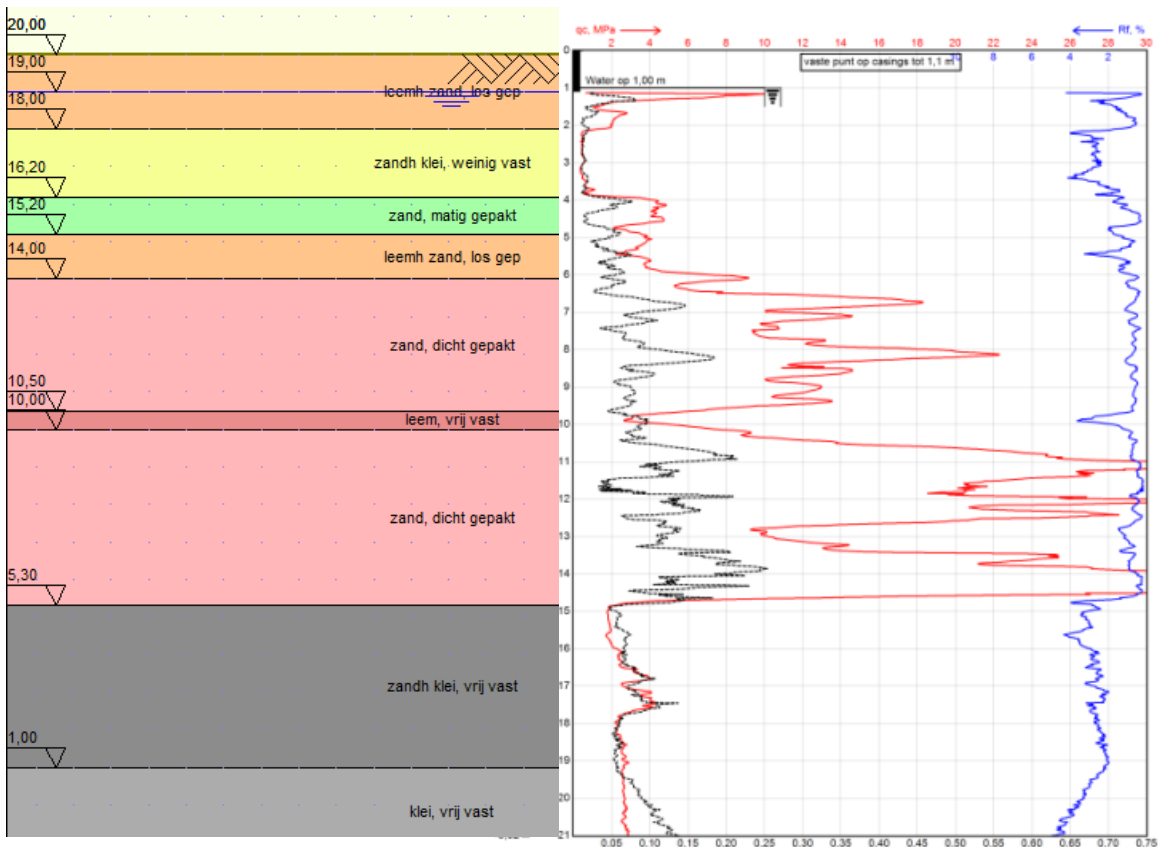

Figure 23: CPT S2 – Biestebroeck (source: Technum)

Top level [m TAW]	Description	γ_d [kN/m ²]	γ_n [kN/m ²]	ϕ' [°]	c [kPa]
20.00	sand, silty/clayey, loose	16	18	25	0
18.00	clay, sandy, soft	16	16	22	2
16.20	sand, moderate	17	19	30	0
15.20	sand, silty/clayey, loose	16	18	25	0
14.00	sand, dense	18	20	35	0
10.50	silt, dense	19	19	22	4
10.00	sand, dense	18	20	35	0
5.30	clay, sandy, dense	18	18	22	8
1.00	clay, dense	18	18	20	8

Table 1: Soil properties - Biestebroek - S2 (source: Technum)

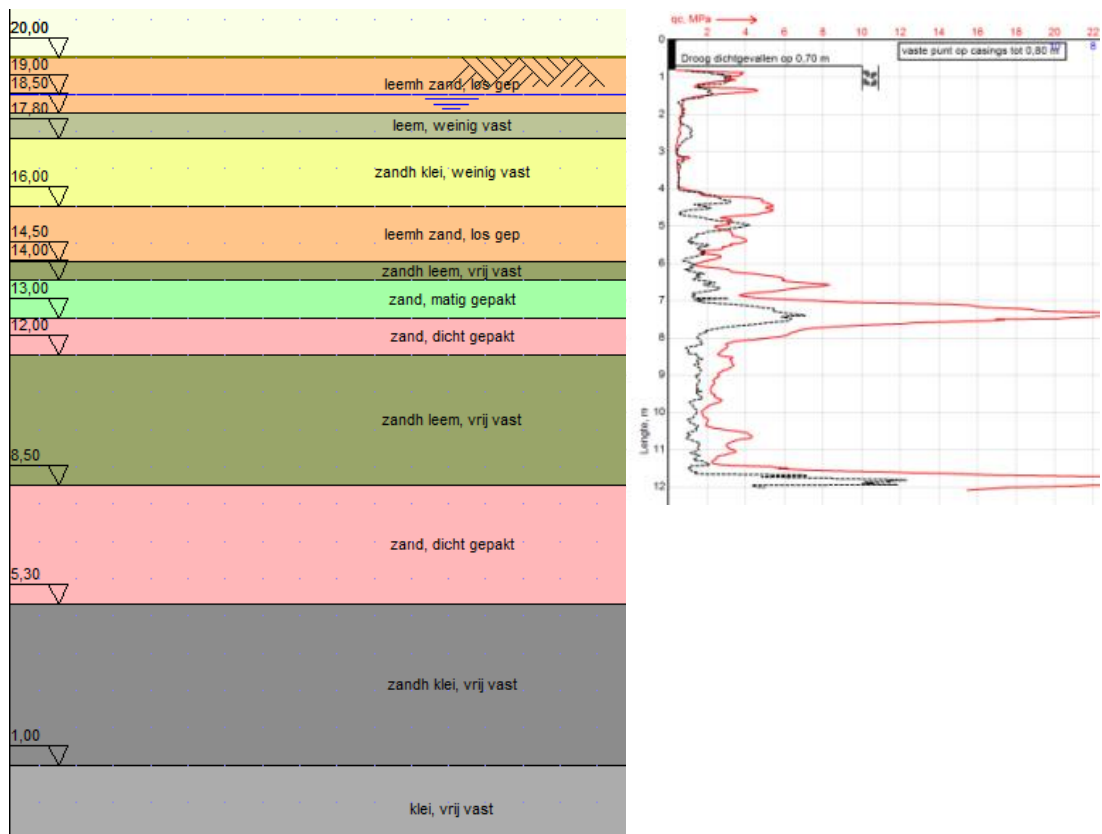

Figure 24: CPT S3 – Biestebroek (source: Technum)

Top level [m TAW]	Description	γ_d [kN/m²]	γ_n [kN/m²]	ϕ' [°]	c [kPa]
20.00	sand, silty/clayey, loose	16	18	25	0
18.50	silt, soft	17	17	22	0
17.80	clay, sandy, soft	16	16	22	2
16.00	sand, silty/clayey, loose	16	18	25	0
14.50	silt, sandy, dense	19	19	25	4
14.00	sand, moderate	17	19	30	0
13.00	sand, dense	18	20	35	0
12.00	silt, sandy, dense	19	19	25	4
8.50	sand, dense	18	20	35	0
5.30	clay, sandy, dense	18	18	22	8
1.00	clay, dense	18	18	20	8

Table 2: Soil properties - Biestebroek - S3 (source: Technum)

3.1.2.4.2 Zone Vergote Dock

Soil properties are determined based on following CPTs (see Figure 25):

- 3 CPT's from SGS, dd.3/7/2013

S4 could not penetrate the upper soil layer. After several trials, the CPT was ended. The definition of the layers and their soil properties are given in Table 3 and Table 4.

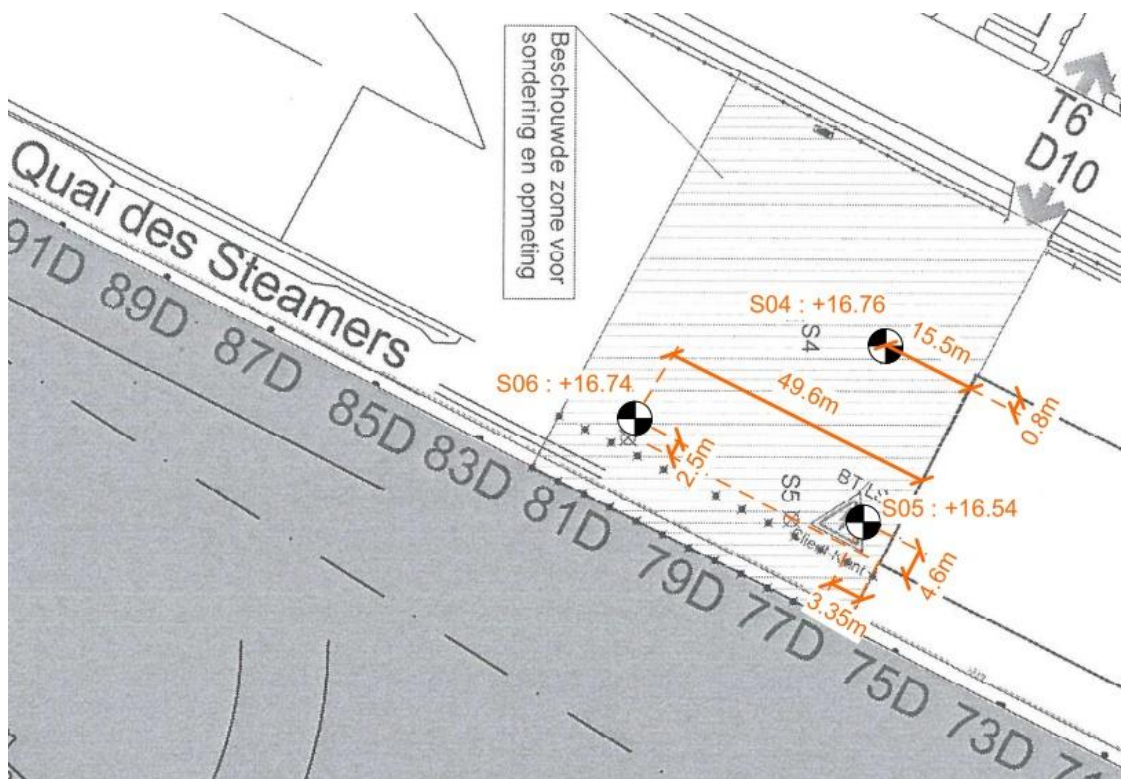

Figure 25: Location CPTs – Vergote Dock (source: Technum)

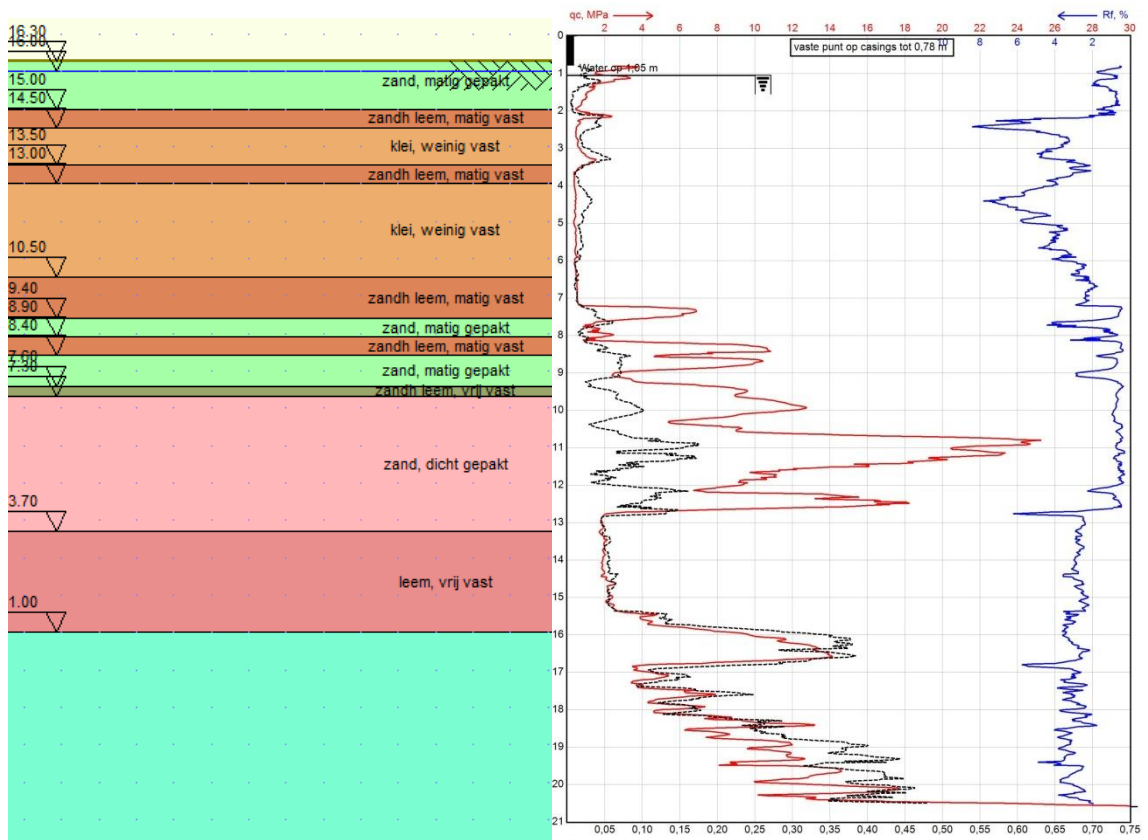

Figure 26: CPT S5 – Vergote Dock (source: Technum)

<i>Top level [m TAW]</i>	<i>Description</i>	γ_d [kN/m ²]	γ_n [kN/m ²]	ϕ' [°]	c [kPa]
16.50	sand, moderate	17	19	30	0
15.00	silt, sandy, moderate	18	18	25	2
14.50	clay, soft	16	16	20	2
13.50	silt, sandy, moderate	18	18	25	2
13.00	clay, soft	16	16	20	2
10.50	silt, sandy, moderate	18	18	25	2
9.40	sand, moderate	17	19	30	0
8.90	silt, sandy, moderate	18	18	25	2
8.40	sand, moderate	17	19	30	0
7.60	silt, sandy, dense	19	19	25	4
7.30	sand, dense	18	20	35	0
3.70	silt, dense	19	19	22	4
1.00	clay, sandy, stiff	19	19	22	15

Table 3: Soil properties – Vergote Dock – S5 (source: Technum)

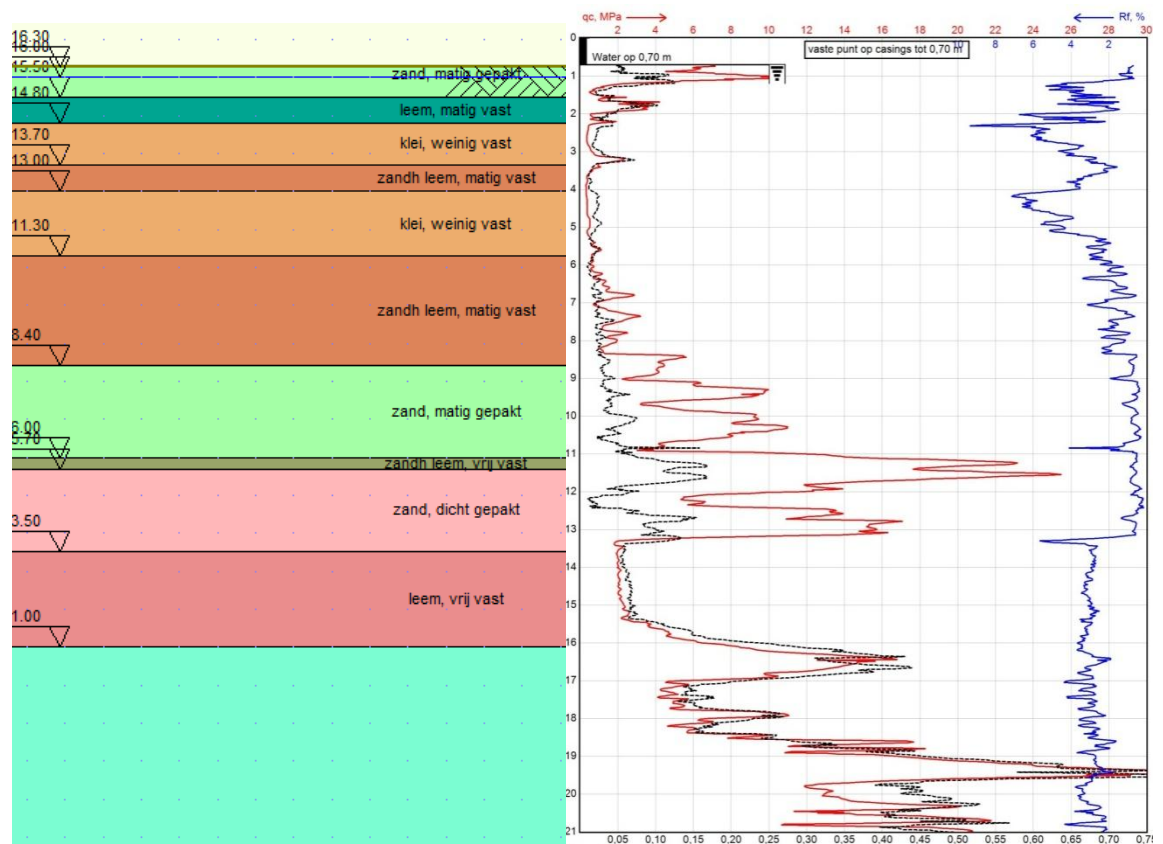

Figure 27: CPT S6 – Vergote Dock (source: Technum)

<i>Top level [m TAW]</i>	<i>Description</i>	<i>γ_d [kN/m²]</i>	<i>γ_n [kN/m²]</i>	<i>ϕ' [°]</i>	<i>c [kPa]</i>
16.70	sand, moderate	17	19	30	0
15.50	silt, moderate	18	18	22	2
14.80	clay, soft	16	16	20	2
13.70	silt, sandy, moderate	18	18	25	2
13.00	clay, soft	16	16	20	2
11.30	silt, sandy, moderate	18	18	25	2
8.40	sand, moderate	17	19	30	0
6.00	silt, sandy, dense	19	19	25	4
5.70	sand, dense	18	20	35	0
3.50	silt, dense	19	19	22	4
1.00	clay, sandy, stiff	19	19	22	15

Table 4: Soil properties – Vergote Dock – S6 (source: Technum)

3.1.3 Feasibility of the logistic concept

3.1.3.1 Soil resistance - Gravity wall

As mentioned before, the concrete/brick block on the platform will be investigated as being positioned on the platform without any fixation. The maximum acceptable loads behind the block will be determined based on the safety philosophy of the current Eurocode.

Sliding and overturning is checked according to the EQU criterion of Eurocode 7.

Permanent unfavourable	1,1
Permanent favourable	0,9
Variable unfavourable	1,5
Variable favourable	0
Tan (fi)	1,25

Table 5: Safety parameters EQU Eurocode 7 (source: Technum)

The most unfavorable situation is when no loads are on top of the block and the maximum load is just behind the block. The maximum load is determined for a minimum safety of 1 in ULS, both for sliding and overturning.

3.1.3.1.1 Biestebroek Dock

A Without bollard loads

B With bollard loads

Mobile load		V	H	x	y	M
0 kN/m ²		[kN/m]	[kN/m]	[m]	[m]	[kNm/m]
V _{total, d}	Structure - self weight	49.9		0.60		30.0
Q _a	Active soil pressure	3.2	12.8	1.20	0.72	-5.4
Q _{bollard}	Bollard load		15.00		2.00	-30
W	Water pressure		7.2		0.34	-2.48
P Total		53.1	35.0	0.64	1.19	-7.89
		(1)	(2)			
μ		0.6		(3)		
Vd = μ(V_{tot,d}+Q_{av,d})		31.87 kN		(4)	=(1)*(3)	
Safety						
- sliding		0.91		=(4)/(2)		
- overturning		0.79		=M ⁺ /M ⁻		

Table 7: Stability upper structure - Biestebroeck - with bollard loads 200 kN (source: Technum)

No allowable safety factor is found for a bollard load of 200 kN.

For bollard loads of 150 kN, the required safety factors are nearly reached. No mobile load is still allowed.

Mobile load		V	H	x	y	M
0 kN/m ²		[kN/m]	[kN/m]	[m]	[m]	[kNm/m]
V _{total, d}	Structure - self weight	49.9		0.60		30.0
Q _a	Active soil pressure	3.2	12.8	1.20	0.72	-5.4
Q _{bollard}	Bollard load		11.25		2.00	-22.5
W	Water pressure		7.2		0.34	-2.48
P Total		53.1	31.3	0.64	1.09	-0.39
		(1)	(2)			
μ		0.6		(3)		
Vd = μ(V_{tot,d}+Q_{av,d})		31.87 kN		(4)	=(1)*(3)	
Safety						
- sliding		1.02		=(4)/(2)		
- overturning		0.99		=M ⁺ /M ⁻		



Table 8: Stability upper structure - Biestebroek – with reduced bollard loads 150 kN (source: Technum)

3.1.3.1.2 Vergote Dock

A Without bollard loads

Mobile load		V	H	x	y	M
6 kN/m ²		[kN/m]	[kN/m]	[m]	[m]	[kNm/m]
V _{total, d}	Structure - self weight	120.8		1.38		166.3
Q _a	Active soil pressure	10.2	33.3	2.85	1.30	-14.2
Q _{bollard}	Bollard load		0.00		3.30	0
W	Water pressure	5.75	48.8	2.43	1.01	-35.5
P	Total	136.7	82.1	1.53	1.13	116.6
		(1)	(2)			
	μ	0.6		(3)		
	$V_d = \mu(V_{tot,d} + Q_{av,d})$	82.00 kN		(4)	=(1)*(3)	
	Safety					
	- sliding	1.00		=(4)/(2)		
	- overturning	3.35		=M ⁺ /M ⁻		

Table 9: Stability upper structure – Vergote Dock - without bollard loads (source : Technum)

B With bollard loads

Mobile load		V	H	x	y	M
2 kN/m ²		[kN/m]	[kN/m]	[m]	[m]	[kNm/m]
V _{total, d}	Structure - self weight	120.8		1.38		166.3
Q _a	Active soil pressure	7.5	25.4	2.85	1.23	-9.6
Q _{bollard}	Bollard load		6.00		3.30	-19.8
W	Water pressure	5.75	48.8	2.43	1.01	-35.5
P	Total	134.1	80.2	1.50	1.25	101.4
		(1)	(2)			
μ		0.6		(3)		
V_d = μ(V_{tot,d}+Q_{av,d})		80.43 kN		(4)		=(1)*(3)
Safety						
- sliding		1.00				=(4)/(2)
- overturning		2.56				=M ⁺ /M ⁻

Table 10: Stability upper structure – Vergote Dock - with bollard load 200 kN (source: Technum)

Mobile load		V	H	x	y	M
3 kN/m ²		[kN/m]	[kN/m]	[m]	[m]	[kNm/m]
V _{total, d}	Structure - self weight	120.8		1.38		166.3
Q _a	Active soil pressure	8.2	27.4	2.85	1.25	-10.8
Q _{bollard}	Bollard load		4.50		3.30	-14.85
W	Water pressure	5.75	48.8	2.43	1.01	-35.5
P	Total	134.7	80.7	1.51	1.22	105.2
		(1)	(2)			
μ		0.6		(3)		
V_d = μ(V_{tot,d}+Q_{av,d})		80.83 kN		(4)		=(1)*(3)
Safety						
- sliding		1.00				=(4)/(2)
- overturning		2.72				=M ⁺ /M ⁻

Table 11: Stability upper structure – Vergote Dock - with bollard load 150 kN (source: Technum)

3.1.3.1.3 Summary

Mobile load q, max [kN/m ²]	Biestebroeck	Vergotedok
Without bollard loads	11	6
With bollard loads – 200 kN	-	2
With bollard loads – 150 kN	0	3

Table 12 : Stability upper structure – overview (source : Technum)

In any case, based on the safety principles of Eurocode, **the upper structure is not able to support a mobile load of 60 kN/m²** (=6 ton/m²). If pallet transport corresponds with 40 kN/m² (= 4 ton/m²), then both docks are also not able to carry that weight immediately behind the wall (restrictions).

3.1.3.2 Pile resistance

The pile resistances are determined according to the "Recommendations for the application of Eurocode 7 in Belgium. Part 1: Geotechnical design in ultimate limit state of axial loaded piles." prepared by WTCB.

Loads are defined for combination 2 as in Eurocode, which is for geotechnical design determining.

3.1.3.2.1 Biestebroeck Dock

The compressive resistance of each pile in the considered quay wall is **1100 kN**. The determining CPT is S3. The calculation of the resistance is given in ANNEX 4 .

3.1.3.2.2 Vergote Dock

The compressive resistance of each pile in the considered quay wall is **378 kN**. The determining CPT is S6. The calculation of the resistance is given in ANNEX 5 .

3.1.3.3 Pile load

The pile loads are determined with "Dsheet" and "SCIA Engineer". DSheet is used to determine the reaction of the sheet pile wall on the pile structure (with platform). The reaction is determined for the serviceability limit state. Displacements should be almost similar at the top of the sheet pile wall as at the back of the platform.

3.1.3.3.1 Biestebroek Dock

The reaction from the sheet pile wall is modeled for both S2 and S3. Both CPTs give similar results in case the sheet pile wall is fixed at the top. Further calculations have only been carried out for S2. The external loads have been implemented according to combination 2 of Eurocode.

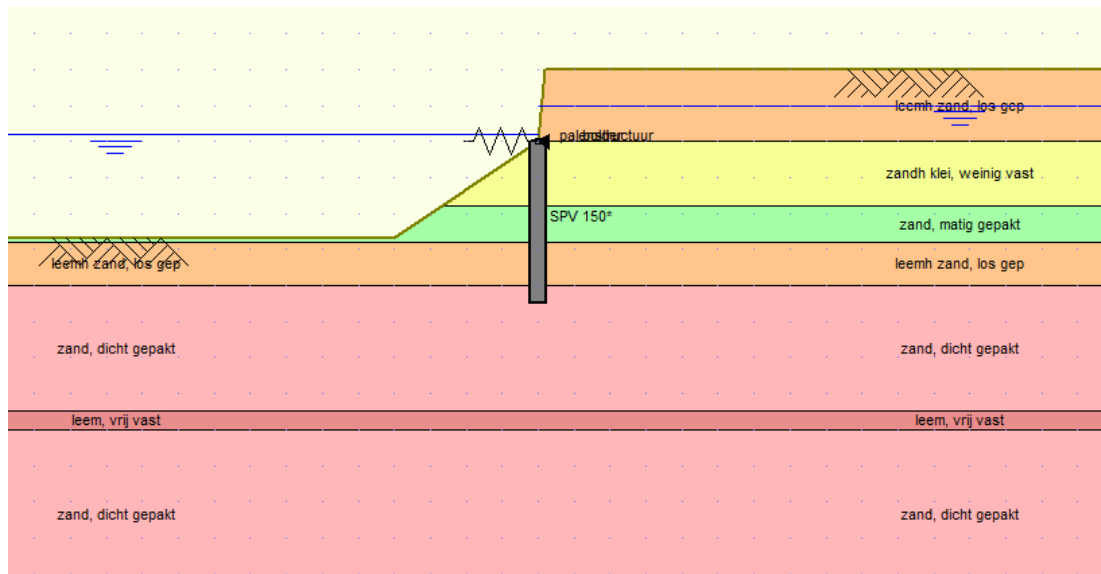

Figure 28: DSheet - Modeling sheet pile wall - Biestebroek Dock (source: Technum)

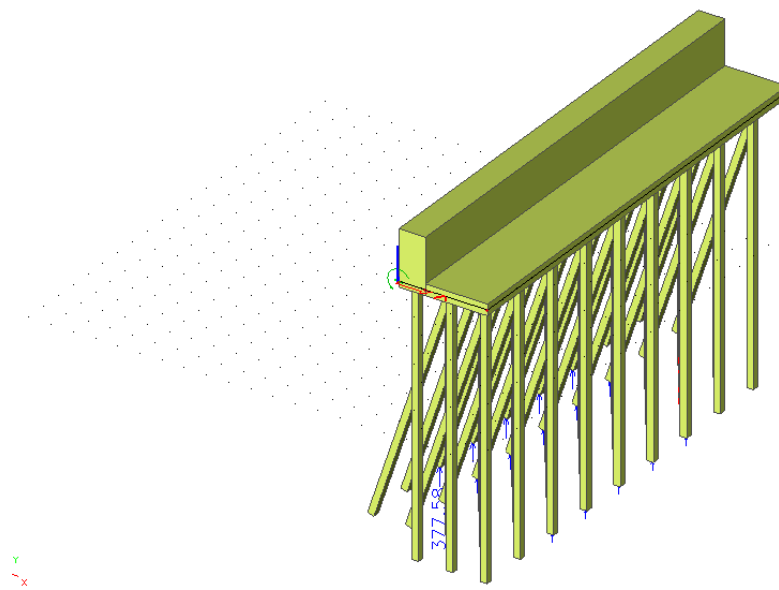

Figure 29: SCIA Engineer – Modeling pile structure - Biestebroek Dock (source: Technum)

Several conditions have been checked with and without bollard load (150 kN):

- No mobile load on and behind the quay wall;
- 20 kN/m² behind the quay wall;
- 20 kN/m² on and behind the quay wall;
- 40 kN/m² behind the quay wall;
- 40 kN/m² on and behind the quay wall;
- 60 kN/m² behind the quay wall;
- 60 kN/m² on and behind the quay wall.

<i>Mobile load</i>	<i>Behind quay</i>	<i>On quay</i>	<i>Reaction sheet pile wall</i>	<i>Q_{pile} without bollard</i>	<i>Q_{pile} with bollard</i>
			[kN/m]	[kN]	[kN]
0 kN/m²			35.3	162.5	181.2
20 kN/m²	x		37.3	166.2	185.1
20 kN/m²	x	x	63.0	269.3	288.2
40 kN/m²	x		42.0	175.5	194.5
40 kN/m²	x	x	91.3	377.6	396.5
60 kN/m²	x		47.6	186.6	205.6
60 kN/m²	x	x	120.3	487.2	506.1
Par. 3.1.3.2.1				<1100 kN	< 1100 kN

Table 13: Pile loads – Biestebroeck Dock – with/without bollard (150 kN) (source: Technum)

According to these calculations the piles have sufficient resistance for mobile loads up to 60 kN/m² on and behind the quay wall, with and without bollard loads.

3.1.3.3.2 Vergote Dock

The reaction from the sheet pile wall is modeled for both S5 and S6. Both CPTs give similar results in case the sheet pile wall is fixed at the top. Further calculations have only been carried out for S6. The external loads have been implemented according to combination 2 of Eurocode.

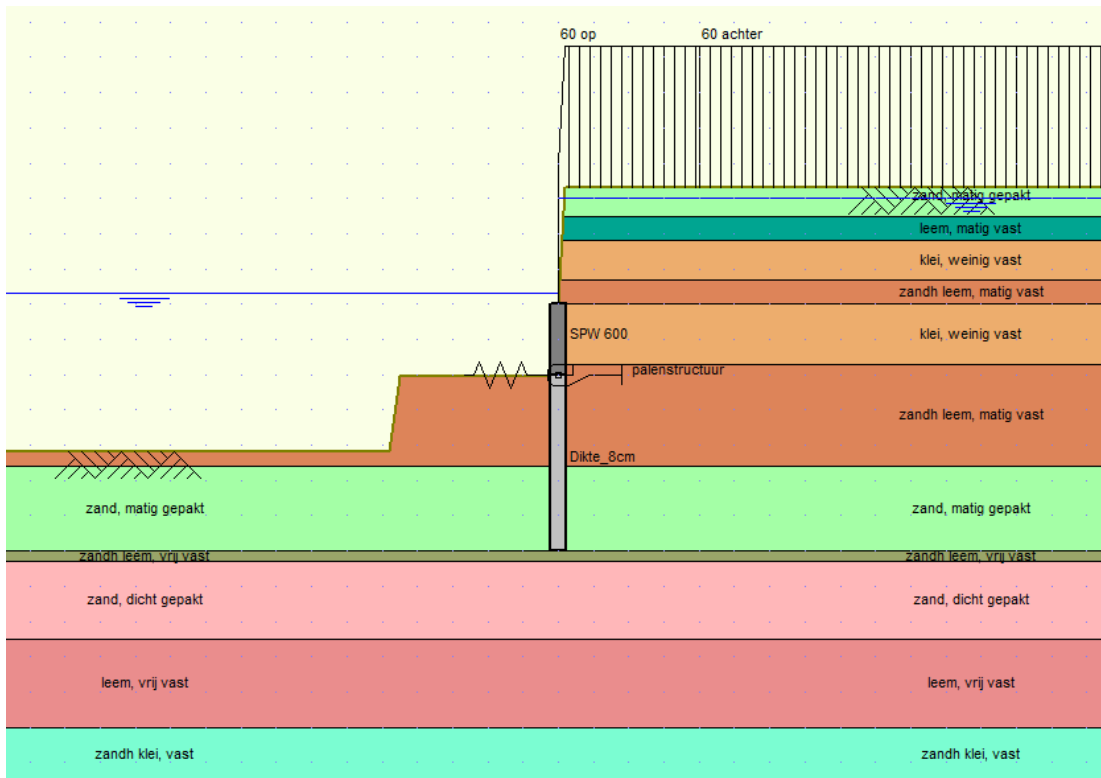

Figure 30: DSheet - Modeling sheet pile wall - Vergote Dock – e.g. Mobile load 60 kN/m² (source: Technum)

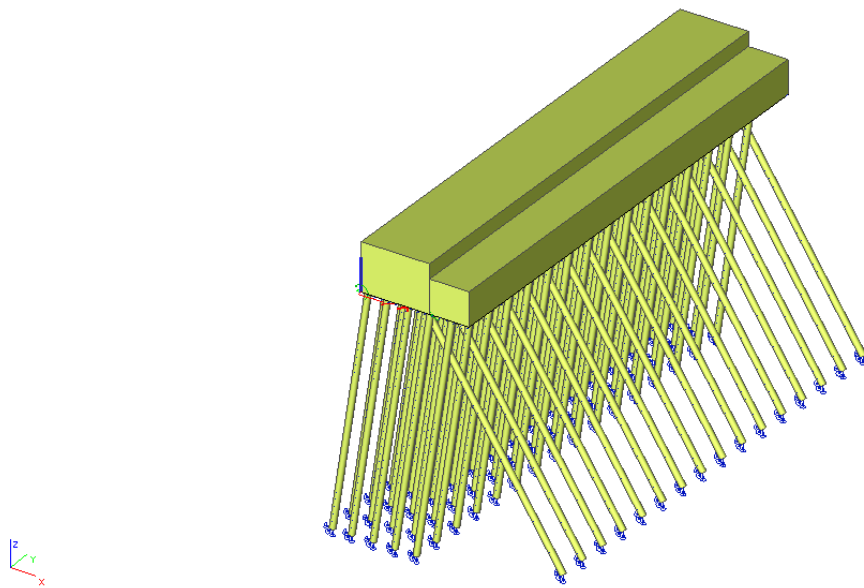

Figure 31: SCIA Engineer – modelling pile structure - Vergote Dock (source: Technum)

Several conditions have been checked with and without bollard load (200 kN):

- No mobile load on and behind the quay wall;
- 20 kN/m² behind the quay wall;
- 20 kN/m² on and behind the quay wall;
- 40 kN/m² behind the quay wall;
- 40 kN/m² on and behind the quay wall;
- 60 kN/m² behind the quay wall;
- 60 kN/m² on and behind the quay wall.

Mobile load	Behind quay	On quay	Reaction sheet pile wall	Q_{pile} without bollard	Q_{pile} with bollard
			[kN/m]	[kN]	[kN]
0 kN/m²			119.7	151.2	151.2
20 kN/m²	x		136.5	153.7	153.7
20 kN/m²	x	x	169.8	198.8	198.8
40 kN/m²	x		158.3	157	157
40 kN/m²	x	x	221.3	246.5	246.5
60 kN/m²	x		182.7	160.7	160.7
60 kN/m²	x	x	274.6	294.6	294.6
Par. 3.1.3.2.2				< 378 kN	< 378 kN

Table 14: Pile loads – Biestebroek Dock – with/without bollard (200 kN) (source: Technum)

According to these calculations the piles have sufficient resistance for mobile loads up to 60 kN/m² on and behind the quay wall, with and without bollard loads.

3.1.3.4 Soil resistance – Bearing capacity

The bearing capacity of the existing area is investigated based on the CPTs. The bearing capacity is determined for a uniform centric load. The area and the shape of the loading area (that is seen as a foundation slab) determine the strength of the soil. Larger areas have an impact on the deeper soil layers.

The study is based on the principles in Eurocode 7. The general formula is:

$$R/A' = c' N_c b_c s_c i_c + q' N_q b_q s_q i_q + 0,5 \gamma' B' N_\gamma b_\gamma s_\gamma i_\gamma$$

With:

- $b_c = b_q = b. = 1$ (no inclination of loading area);
- $i_c = i_q = i. = 1$ (no inclined loads);
- $q' = 0$ (no loads near loading area);
- $c' = c_{eq}$ en $\gamma' = \gamma_{eq}$ (calculating based on the layering and influence depth);
- Bearing factors and shape factors to be calculated based on ϕ_{eq} (also based on the layering and influence depth);
- B' is similar to the width of the loading area (because it is a centric load).

$$R/A' = c' N_c b_c s_c i_c + q' N_q b_q s_q i_q + 0,5 \gamma' B' N_\gamma b_\gamma s_\gamma i_\gamma$$

Following safety factors are applied based on EC7 – annex A:

- Internal friction: $\gamma_f = 1.25$ (on $\tan(\phi)$);
- Cohesion: $\gamma_f = 1.25$;
- Variable load: $\gamma_f = 1.30$.

To take into account the soil layers, the methodology as proposed in NEN 6744 is applied. Soil parameters are then determined as the weighted average along the influence depth of the foundation/loading area.

3.1.3.4.1 Biestebroek Dock

For the upper 1 m no soil characteristics can be determined based on the CPTs. Due to compaction and based on the information of the upper layers, an internal friction of 27° is taken into account for the upper 1 m.

Following maximum loads are allowed, depending of the loading area:

Width [m]	Length [m]	Max. load [kN/m²]
1	1	24
1	2	29
1	3	31
2	2	37
2	3	42
2	6	47
3	3	47

Table 15 : *Bearing capacity – Biestebroeck Dock – S2 (source: Technum)*

Width [m]	Length [m]	Max. load [kN/m²]
1	1	24
1	2	29
1	3	31
2	2	34
2	3	39
2	6	44
3	3	43

Table 16: *Bearing capacity – Biestebroeck Dock – S3 (source: Technum)*

3.1.3.4.2 Vergote Dock

For the upper 1 m no soil characteristics can be determined based on the CPTs. The same characteristics have been applied as for the underlying layers.

Following maximum loads are allowed, depending of the loading area:

Width [m]	Length [m]	Max. load [kN/m²]
1	1	33
1	2	39
1	3	42
2	2	52
2	3	58
2	6	64
3	3	60

Table 17: Bearing capacity – Vergote Dock – S5 (source: Technum)

Width [m]	Length [m]	Max. load [kN/m²]
1	1	36
1	2	43
1	3	46
2	2	55
2	3	63
2	6	70
3	3	64

Table 18: Bearing capacity – Vergote Dock – S6 (source: Technum)

3.1.4 Conclusions - allowable loads behind quay wall

3.1.4.1 Biestebroeck Dock

The stability of the quay wall is determined by the sliding and/or overturning of the gravity wall on top of the platform. NO bollard loads of 200 kN are allowed. Only lower bollard loads of 150 kN can be allowed, with restrictions to the mobile loads. Without any bollard loads, the quay wall is not stable for a mobile load of 60 kN/m² immediately behind the gravity wall. Restrictions to the mobile loads are given. These restrictions are based on the pressure increment at the back of the gravity wall due to the mobile load.

- **Only mobile load of:**
 - o 11 kN/m² from 0 m behind quay wall
 - o or 20 kN/m² from 2 m behind quay wall
 - o or 40 kN/m² from 3 m behind quay wall
 - o **or 60 kN/m² from 3.5 m behind quay wall**
- **No bollard load of 200 kN possible**
- Bollard load of 150 kN combined with mobile load of:
 - o 10 kN/m² from 6 m behind quay wall
 - o or 20 kN/m² from 8 m behind quay wall
 - o or 40 kN/m² from 9 m behind quay wall
 - o or 60 kN/m² from 10 m behind quay wall

These restrictions are included in our platform layout (see map 3).

3.1.4.2 Vergote Dock

The stability of the quay wall is determined by the sliding and/or overturning of the gravity wall on top of the platform. Only bollard loads of 200 kN or 150 kN can be allowed, with restrictions to the mobile loads. Without any bollard loads, the quay wall is not stable for a mobile load of 60 kN/m² immediately behind the gravity wall. Restrictions to the mobile loads are given. These restrictions are based on the pressure increment at the back of the gravity wall due to the mobile load.

The bollard load has less influence than the mobile loads. The biggest difference with Biestebroeck Dock is the difference in water table. Due to the water pressure at the back of the gravity wall, less increment in earth pressure due to the mobile load is allowed.

Current quay wall is able to resist:

- **Only mobile load of:**
 - 6 kN/m² from 0 m behind quay wall
 - or 10 kN/m² from 4 m behind quay wall
 - or 20 kN/m² from 5 m behind quay wall
 - or 40 kN/m² from 6.5 m behind quay wall
 - or **60 kN/m² from 7.5 m behind quay wall**

- **Bollard load of 200 kN combined with mobile load of:**
 - 2 kN/m² from 0 m behind quay wall
 - or 10 kN/m² from 6 m behind quay wall
 - or 20 kN/m² from 7.5 m behind quay wall
 - or 40 kN/m² from 9 m behind quay wall
 - or **60 kN/m² from 10 m behind quay wall**

- **Bollard load of 150 kN combined with mobile load of:**
 - **3 kN/m² from 0 m behind quay wall**
 - or 10 kN/m² from 5.5 m behind quay wall
 - or 20 kN/m² from 6.5 m behind quay wall
 - or 40 kN/m² from 8 m behind quay wall
 - or 60 kN/m² from 9 m behind quay wall

These restrictions are included in our platform layout (see maps 9 to 12).

3.1.5 Strengthening proposal

3.1.5.1 Examples of quay wall reinforcement

3.1.5.1.1 Port of Ostend – REBO site

The old quay wall was not able to resist the new design loads of 100 kN/m². The old quay wall is a platform supported by inclined piles. A new quay wall was built above the old quay wall. The front side of the quay wall is supported by a combi-wall (piles+sheet piles) ; the rear side is supported by 2 extra piles. Cost price ca. 15.000 €/m.

This reinforcement supports on the old quay wall, which is situated 1.30 m below ground level.

COUPE DE PRINCIPE PROJET
(ALTITUDES IGN 69 NORMAL)

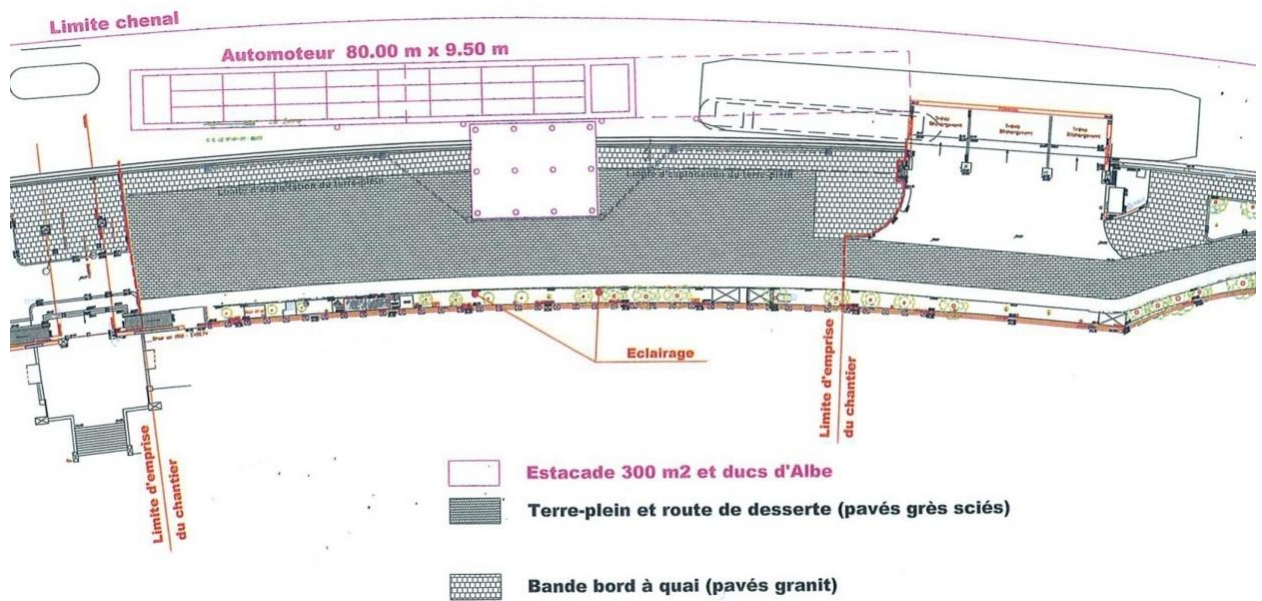
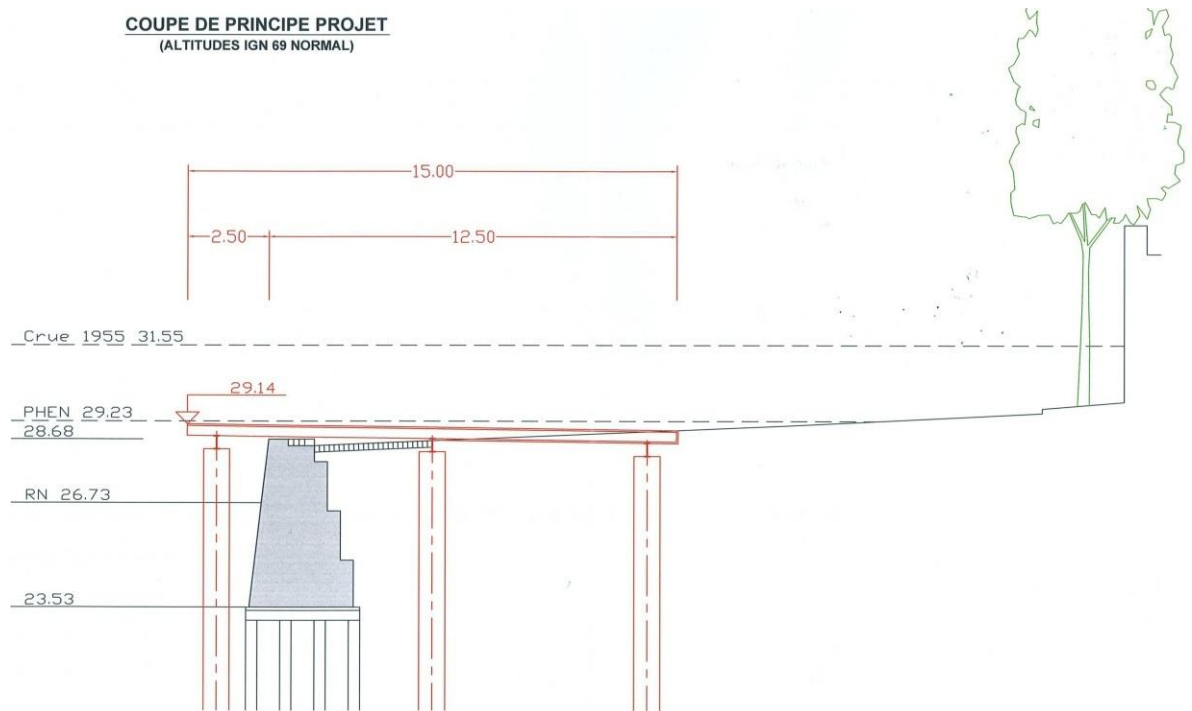

Figure 34: Port de la Bourdonnais – Paris – design of the reinforced quay wall (source: Port of Paris)



Figure 35: Port de la Bourdonnais – Paris – view of the reinforced quay wall (source: Technum)

3.1.5.2 Proposal for Biestebroeck dock

As the gravity wall on top of the platform is not reinforced, it cannot be fixed by an anchor. Excavation of the soil behind the quay wall is preferably restricted to 0.5 m, and absolutely not allowed when deeper than 1 m due to pollution. For this reason, solutions as proposed in Ostend en Zeebrugge are not applicable.

No bollard loads of 200 kN can be applied on the current structure. In order to berth, 4 new mooring dolphins are necessary, placed in front of the current quay wall. Attention should be paid to the position of the concrete piles. The mooring dolphins and the piles should not interfere with each other. The berthing plane moves minimum 4.5 m dock side.

Along the loading/unloading area, a platform of 25 x 25 m can be constructed, supported by 25 piles when applying a mobile load of 60 kN/m². The length of the piles depend on the pile loads and the soil resistance. Piles on the second row are carrying more loads than other piles.

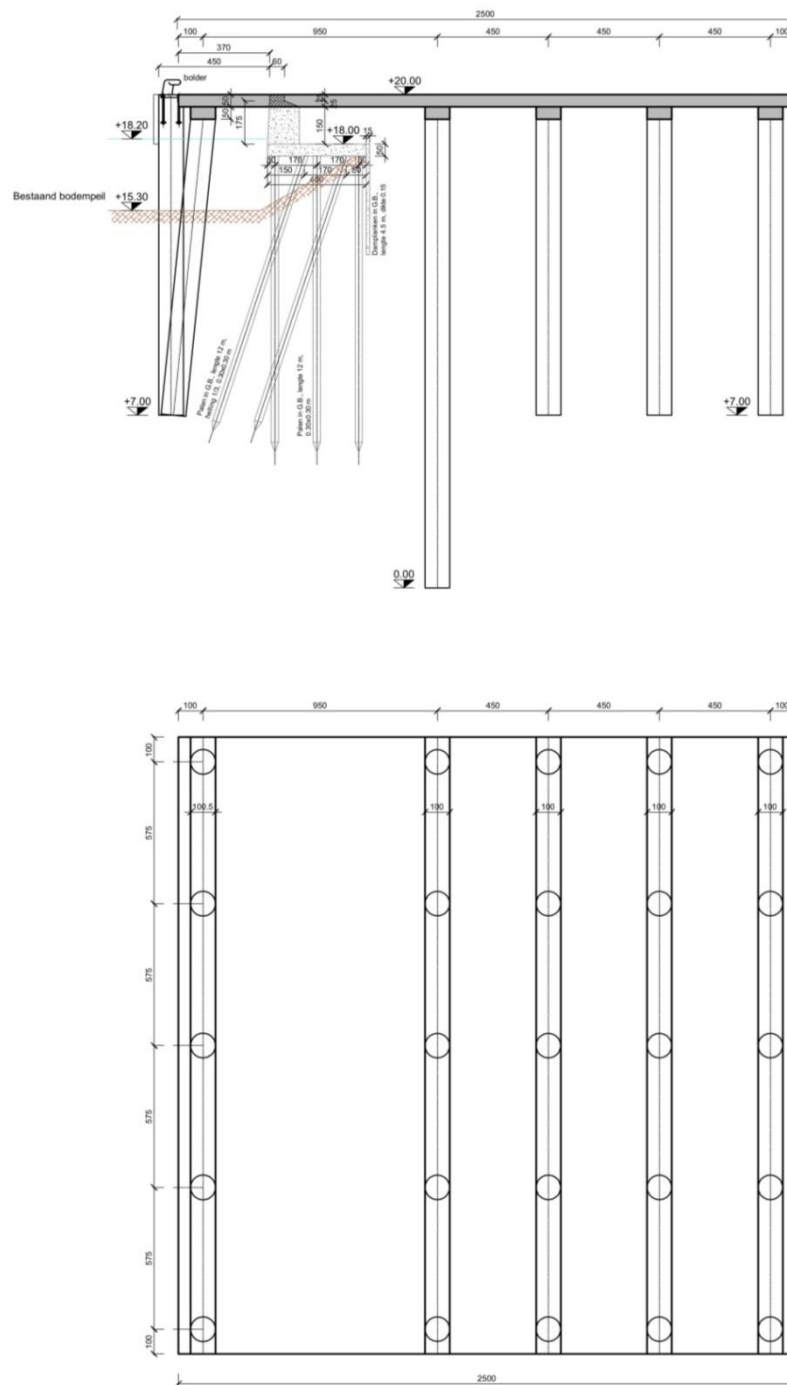

Figure 36: Biestebroek Dock – reinforced quay wall – loading/unloading area (source: Technum)

See also maps 3 and 4 in the Annex for a better view.

Based on a preliminary design the beams have a total height of 1 m (including the height for the plates) and the plates have a thickness of 0.5 m.

The cost estimate for the construction of the reinforced platform is 1.450.000 €/platform.

Structural element	Cost estimate
25 piles + 4 mooring dolphins	700.000 €
Beams	500.000 €
Plate	200.000 €
Installation costs	50.000 €
TOTAL	1.450.000 €

Table 19: Cost estimate – reinforced platform Biestebroek Dock (source : Technum)

This cost is based on a 25m x 25m platform. But it is probably wise to extend the platform until the limit of the area. In this case, the reinforced platform would be 25m x (approximately) 33,7m (see map 4).

Outside the reinforced area, a concrete plate of 30 cm (without piles and beams) is planned. The cost can be estimate at 114.000 €, based on a ratio of 100 €/m².

Due to environmental issue (ground pollution), excavation has to be limited as much as possible and the pumping of the water rising in the excavation is strictly to be avoided. For this reason, we advice to use prefab piles and beams.

3.1.5.3 Proposals for Vergote dock

As the gravity wall on top of the platform is made of bricks, it cannot be fixed by an anchor. The empty area inside the wall can collapse when breaking the upper part of the gravity wall.

As the platform is situated at 3.30 m below ground level and below water level, solutions as proposed in Ostend en Zeebrugge are not easily applicable.

When applying bollard loads on the gravity wall, almost no mobile loads can be allowed on the loading/unloading area. In order to berth, 4 new mooring dolphins are necessary, placed in front of the current quay wall. Attention should be paid to the position of the wooden piles. The mooring dolphins and the piles should not interfere with each other. The berthing plane moves minimum 3.7 m dock side.

Along the loading/unloading area, a reinforced platform of 25 x 25 m can be constructed, supported by 30 piles when applying a mobile load of 60 kN/m². The length of the piles depend on the pile loads and the soil resistance. Piles on the second row are carrying more loads than other piles.

Based on a preliminary design the beams have a height of 1 m and the plates have a thickness of 0.5 m.

The cost estimate for the construction of the reinforced platform for an allowable mobile load of 60 kN/m² is 1.650.000 €/platform. See maps 9 and 13.

Structural element	Cost estimate
30 piles + 4 mooring dolphins	900.000 €
Beams	500.000 €
Plate	200.000 €
Installation costs	50.000 €
TOTAL	1.650.000 €

Table 20: Cost estimate – 25m x 25m reinforced platform Vergote Dock – 60 kN/m² mobile load (source: Technum)

When reducing the load to 40 kN/m², the length of the piles can be reduced. The cost estimate becomes 1.490.000 €/platform. See maps 10 and 14.

When further reducing the length of the platform to 20.5m and 16m, a new cost estimate can be found of resp. 1.245.000 €/platform and 1.000.000 €/platform. See maps 11 and 15, and 12 and 16.

Structural element	Cost estimate		
Platform (width x length)	25m x 25m	25m x 20.5m	25m x 16m
# piles	30	24	18
piles	640.000 €	530.000 €	420.000 €
Mooring dolphins (4)	100.000 €	100.000 €	100.000 €
Beams	500.000 €	400.000 €	300.000 €
Plate	200.000 €	165.000 €	130.000 €
Installation costs	50.000 €	50.000 €	50.000 €
TOTAL	1.490.000 €	1.245.000 €	1.000.000 €

Table 21: Cost estimate – reinforced platform Vergote Dock – 40 kN/m² mobile load (source: Technum)

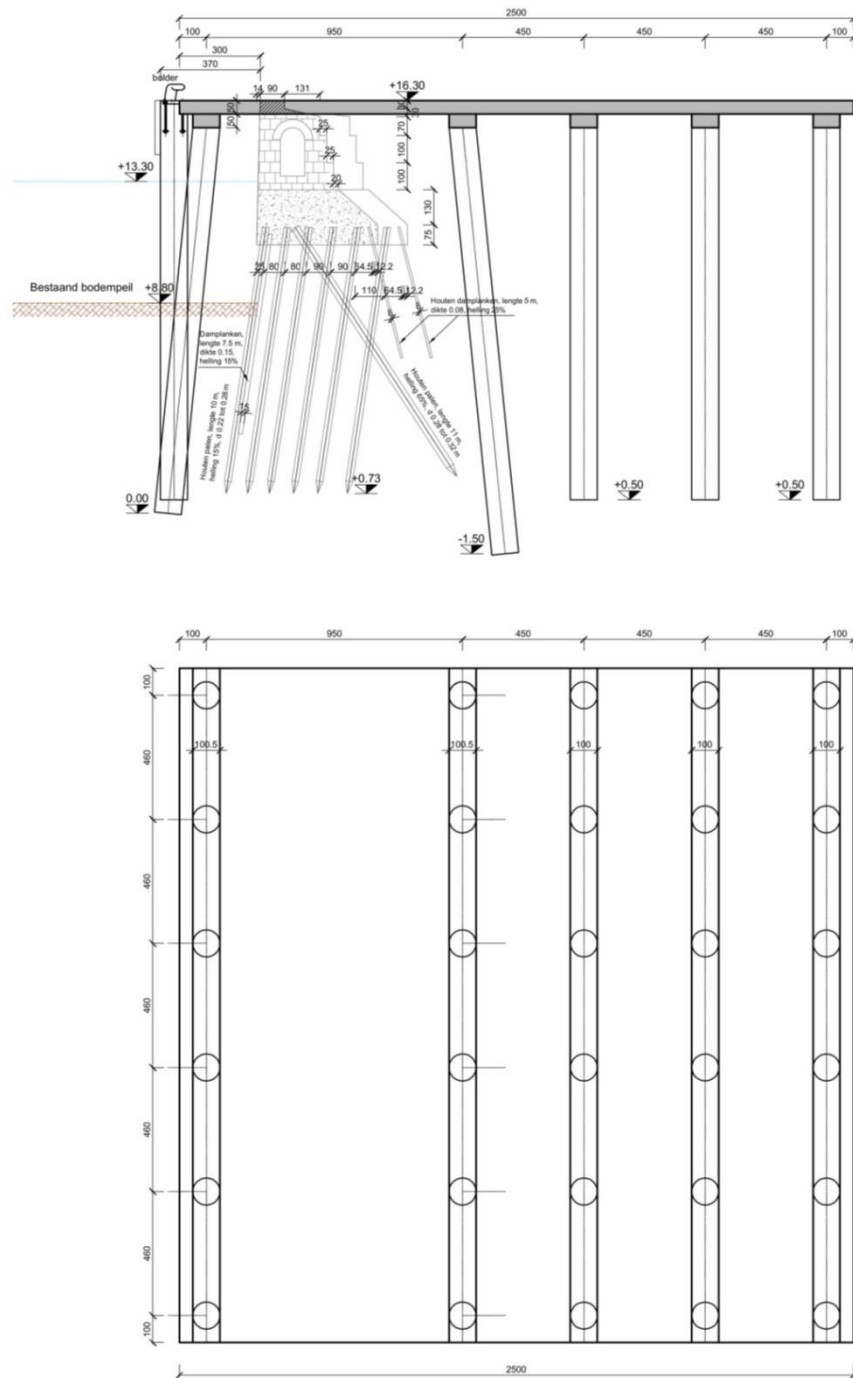

Figure 37: Vergote Dock – reinforced quay wall – loading/unloading area – 60 kN/m² mobile load (source: Technum)

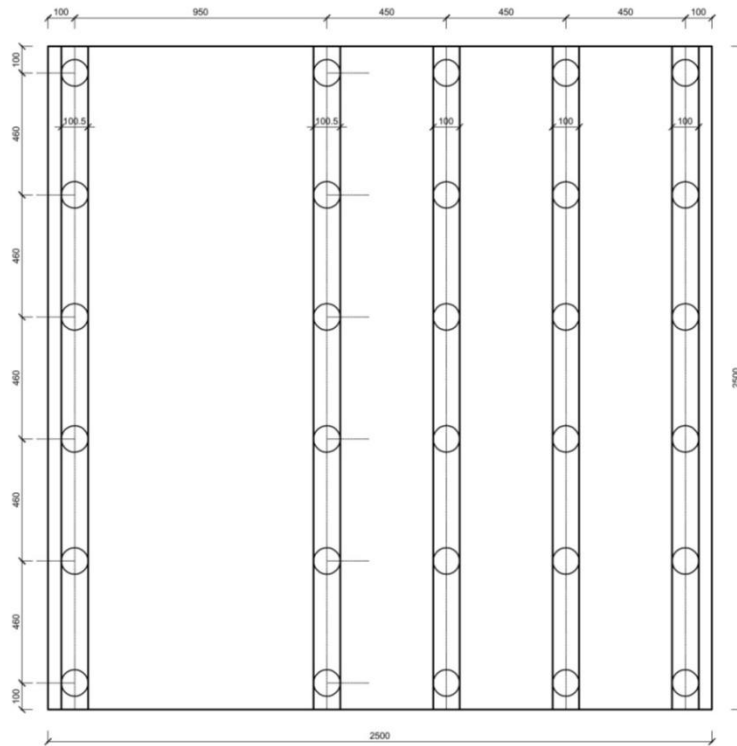
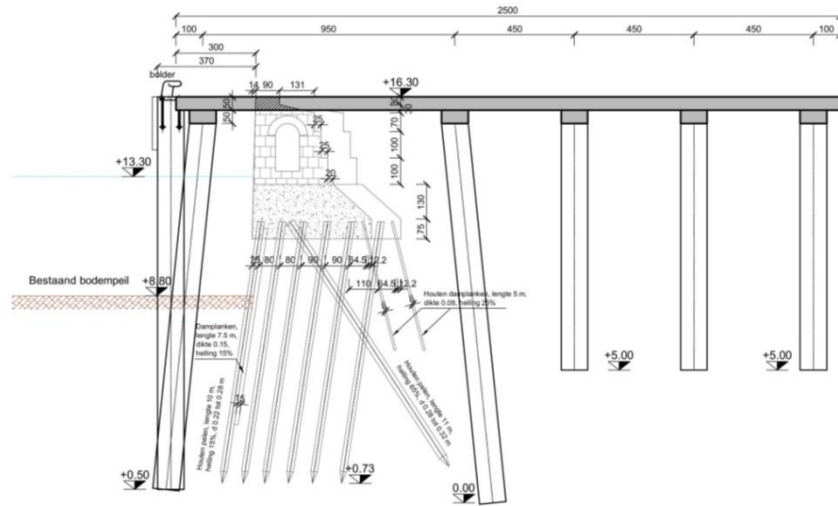

Figure 38: Vergote Dock – reinforced quay wall – loading/unloading area – 40 kN/m² mobile load (source: Technum)

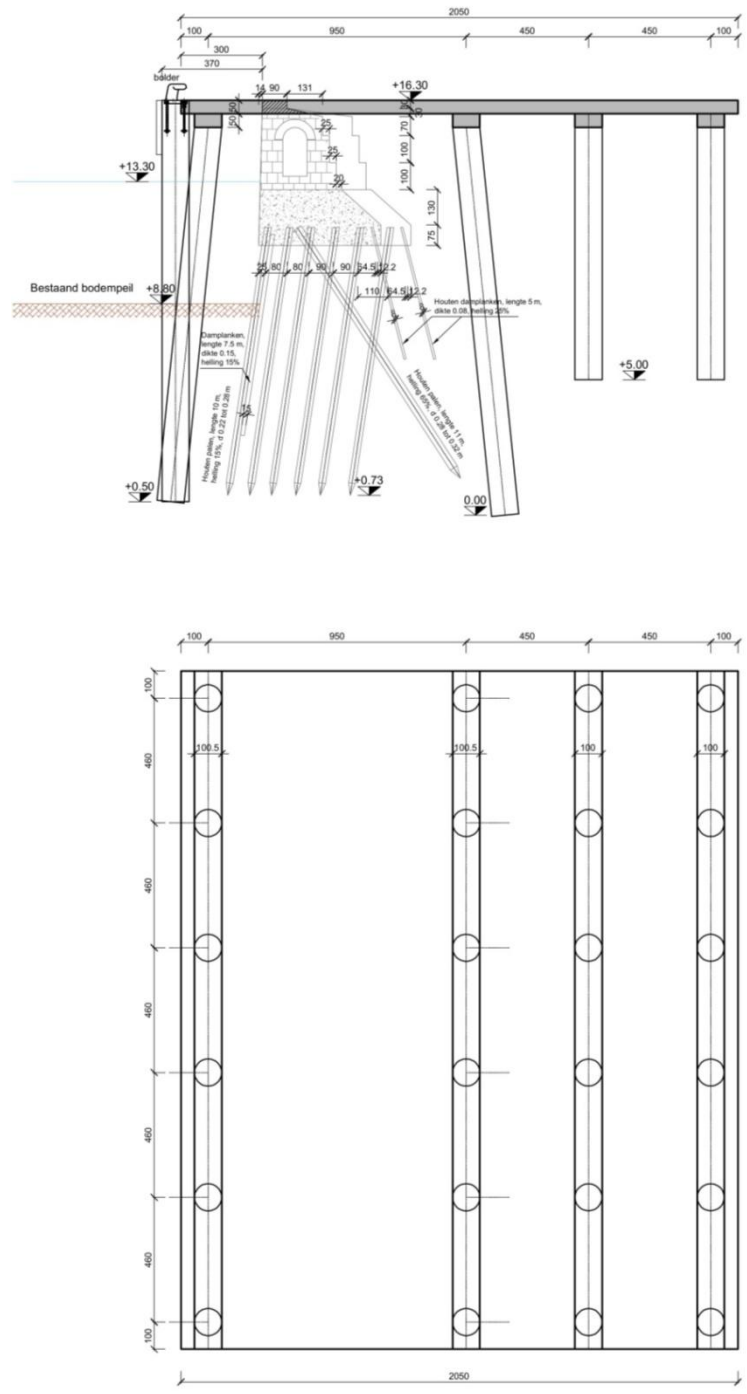

Figure 39: Vergote Dock – reinforced quay wall – loading/unloading area – 40 kN/m² mobile load – reduced platform 25m x 20.5m (source: Technum)

3.2 Phase 2.2: Logistics concepts that meet needs

3.2.1 Introduction

The storage method chosen must be right for the range of goods handled and the use of space.

We have taken the European pallet (more commonly known as a Euro-pallet or EUR-pallet) as our benchmark load support. It measures 120 X 80 X 15 cm and can support a total maximum weight (including the pallet) of 1,500 kg and a maximum height of 180 cm. In practice it is frequently stacked (2 or 3 high), although this is not officially approved by the manufacturers and certification bodies (there is a risk of collapse if the pallets are not correctly aligned, and a risk of the bottom pallet breaking if the combined load exceeds 1,500 kg).



Figure 41: Euro-pallet

3.2.2 Alternative methods for storing packages

We considered a number of alternative storage methods for the two platforms to be built in the Vergote and Biestebroeck docks as part of this project.

The most basic storage method involves simply placing packages on the ground (storage without racking). The necessary ground surface area is equivalent to the surface area used in the boat (with up to 4 levels of stacking).



Figure 42: Pallets stacked with building blocks on 3 or 4 levels

To increase the amount of packages stored, the use of suitable racking may prove an effective solution for minimising the amount of space taken up by different types of non-stackable packages.



Figure 43: Pallets on racking

Our preferred choice would be a combination of these two storage methods according to the type of goods being handled and the level of activity. Accordingly, our operational plans allow for the construction and extension of storage racks, as the layout of the storage rows incorporates the rack dimensions (see Maps 3 and 9 to 12 in the annex). However, in order to retain the space needed for cross-docking and maintain a multifunctional space, it is advised that the racks in the storage areas do not take up more than 1/3 of the surface area.

3.2.3 Storage capacity

It makes sense to make maximum use of the available space according to the storage method chosen.

Three storage methods are being considered:

- On the ground: by stacking (the most common method for storing building blocks); used for specific types of products, although precision is required when placing pallets on top of each other.



Figure 44: Stacked pallets

- On an adjustable pallet rack: the simplest racking system and very common; all pallets can be accessed directly.



Figure 45: Pallet rack

- On a drive-in/drive-through rack: the pallets are placed on storage racks with rails; this enables high-density storage for similar loads in large quantities.



Figure 46: Drive-in/drive-through rack

3.2.4 Determining the storage capacity

The main parameters to consider are the storage space, the maximum available height and the type of racking, including its upright frame (width, height, capacity) and its beam (bearing length).

Based on the layout plan shown on Map 3 (see annex), the ground storage capacity of the Biestebroeck platform would be 256 pallets (or big bags). This figure could be significantly increased by stacking the pallets.

In the case of Vergote, based on the layout plan shown on Map 9 (see annex), the ground storage capacity of the platform would be 656 pallets (or big bags). This figure could be significantly increased by stacking the pallets.

Where the load overhangs the edge of the pallet, the capacity must be reduced by 1/3 compared with the equivalent capacity for pallets whose loads do not overhang.



Figure 47: Overhanging load

3.2.5 Use of the storage space

To ensure maximum flexibility of the platforms, we will make the different zones identical and subject to the constraints associated with the use of covered racking.

Consequently, the ground space taken up by two adjacent pallets is 2.9 m +/- 10 cm, i.e. 2 pallet lengths (2 x 1.2 m), to which we will add at least an additional 40 cm for possible rack feet and covered structure.

For the aisles between two storage spaces, we will provide a useful width of 4.0 m in order to enable storage manoeuvres by a front-loading forklift with pallet, while also allowing two vehicles to pass in the aisle when no storage operation is under way.

See Maps 3 and 9 to 12 in the annex.

3.3 Phase 2.3: Determining the equipment and infrastructure required

3.3.1 Loading/unloading crane

To date, experiments with transporting pallets by waterway (including those carried out by the Port of Brussels) have involved the use of two forklift trucks and an intermediary support structure. This method is relatively economical and efficient but it does present risks in terms of the stability of the boat. It therefore requires the use of a large vessel (Class IV if possible) and extremely careful operators.



Figure 48: Loading at the Wienerberger quay in Rumst (Belgium) using two forklifts and an intermediary support structure (source: Wienerberger)

For pallet-handling involving a significant height difference, we believe that using a hydraulic crane instead of two forklift trucks offers three advantages:

- A single crane operator instead of two forklift operators;
- Better vessel stability as (un)loading does not involve manoeuvres by on-board plant (there have been instances of vessels capsizing at the quayside);
- Stand-alone system that can be used with all types of vessel; goods do not have to be transported on a special boat equipped with a loading/unloading system.



Figure 49: Hydraulic crane with pallet grab

Hydraulic cranes may be set up in two ways depending on the constraints of the site and the multi-purpose chosen:

- Fixed and mounted on a concrete baseplate:



Figure 50: Hydraulic crane on a concrete baseplate built into the quay

- Mobile and mounted on a flatbed truck chassis:



Figure 51: Hydraulic crane mounted on the back of a flatbed truck

The advantage of a flatbed crane truck is its ability to perform two functions totally independently: (un)loading of pallets and transportation on the integrated flatbed. In addition, a licensed truck can drive on the public road network and can therefore perform all kinds of multi-platform transshipment. This would be especially valuable for the Vergote platform (crossing Avenue du Port to the TIR centre).

Waterway operators are also developing on-board cranes (Blue Line, Shipit, Mokum Mariteam in Amsterdam, etc.). This would reduce the amount that has to be spent on platforms while enhancing flexibility.



Figure 52: On-board crane on the City Supplier operated by Mokum Mariteam in Amsterdam (source: Technum)

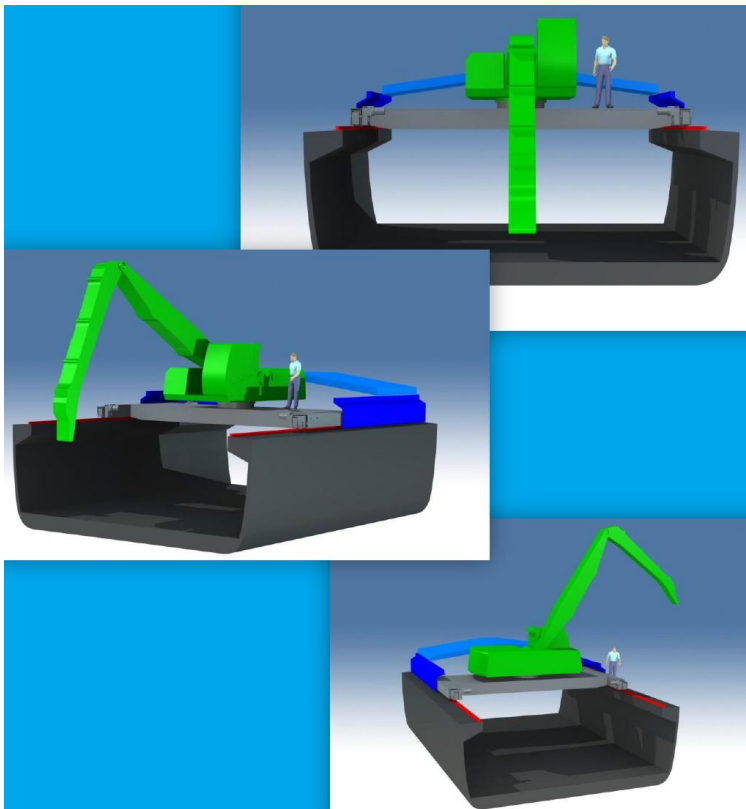

Figure 53: Design for an on-board crane developed by Shipit (source: Knauf)

3.3.2 Industrial lift trucks

Goods may be handled using standard lift trucks or special trucks such as walkies with or without masts.

For long distances, a rider lift truck is more efficient than a traditional manually operated pallet truck. Over a distance of 30 m, transfer using a rider truck is approximately 30% faster than using a walkie.

Depending on the capacity of the load to be handled (1,500 kg), the lift height (1 to 5.5 m), the distance to be travelled and the quality and condition of the underlying surface, the two most suitable lift-truck solutions are as follows:

- Motorised rider stacker with or without mast:



Figure 54: Motorised rider stacker

- Counterbalanced front-loading forklift truck:



Figure 55: Electric front-loading forklift

Electric models are the obvious choice as they are non-polluting.

3.3.3 Reach stacker

The only mobile machinery capable of (un)loading containers onto/off boats from the quay, with negative lift reach, is the reach stacker. It can also perform all container handling operations including racking and truck (un)loading. Use of a reach stacker is a chosen solution for the Biestebroek platform.



Figure 56: Reach stacker

3.3.4 Weighing platform

A low weighing platform, either built into the ground or resting on the ground, enables any type of package to be weighed at any time. It is always wise, in the interests of safety, to double-check the weight of any package in case of doubt.



Figure 57: Weighing platform

3.3.5 Models for different types of trolley, according to the product being handled

A whole range of coupling devices, trolleys/carts and racks are available on the industrial logistics market. The most commonly used models have a ground surface area equivalent to that of a Euro-pallet. This type of equipment could be used for crossing Avenue du Port (see 4).



Figure 58: Various models of wheeled trolleys

Metal-frame solutions are also available which allow big bags to be handled on Euro-pallets.



Figure 59: Big bag on pallet

3.3.6 Logistics operators

In the course of this study, we approached three logistics operators already active in the pallet handling and transport business (mainly construction materials) in the Netherlands and Belgium.

Two of the three operators (Blue Line Logistics and Shipit) are in the process of developing self-unloading vessels. There are two major differences between them, namely the vessel capacity, which ranges from 300 tonnes (approx. 198 pallets) to 1,350 tonnes (approx. 500 pallets), and the capacity of the on-board lifting systems (2T crane – 4.8T crane).

These vessels are due to be launched in September 2013.

The main features of the three operators' proposed systems are summarised in the table below:

	Blue Line Logistics		Shipit		JoGo Shipping	
Concept	Catamaran with crane		Boat with crane		Boat with forklift(s)	
Purpose	Transport and handling of pallets and containers of different types	+	Transport and handling of construction material pallets	+	Transport and handling of pallets Pallet Crossover System	+
Network	Netherlands – Belgium – Germany	+	Netherlands - Belgium	+	Netherlands – Belgium	+
Capacity	300 tonnes max.	+	1300 tonnes max.	+	To be defined	-
Quantity of pallets	approx. 198	+	approx. 500	+	To be defined	-
Cost-effectiveness	Short (un)loading time	+	Combined lifting system for 6 pallets (4.8T)	+	To be defined	-
Financial	Small investment Shareholders OK / Banks!	+/-	Modification of existing vessel	+/-	To be defined	-
Crane	Mobile type Capacity 2T/12 m	+	Mobile type Capacity 4.8T	+	Not applicable	-
Other	Construction started late July 2013 1st unit in Sept. 2013 Total of 3 vessels by Nov. 2013 Rem. 'ballastable' vessel (1.5 m)		Under construction Scheduled launch date Sept. 2013		Very unobtrusive Willing to work to order	

Figure 60: Comparison of the three operators' proposed logistic solutions (source: Technum)

Given the uncertainties surrounding these projects and the desire of the Port of Brussels to develop multi-service/multi-client platforms, we feel that the platform design should enable them to operate independently irrespective of the vessel type.

3.3.7 Proposed equipment for the Biestebroek platform

- Counterbalanced front-loading forklift truck (electric, thermal, etc.)
- Rider stacker (electric, thermal, etc.)
- Weighing platform (integrated into the ground)
- Mobile crane flatbed truck and handling devices
- Big bag on 'pallet' frame
- Reach stacker

3.3.8 Proposed equipment for the Vergote platform

- Counterbalanced front-loading forklift truck (electric, thermal, etc.)
- Rider stacker (electric, thermal, etc.)
- Weighing platform (integrated into the ground)
- Mobile crane flatbed truck and handling devices
- Big bag on 'pallet' frame

Note: an alternative option for crossing Avenue du Port would be an overhead solution such as a pallet lift (raised stacker crane), see 4.

3.3.9 Budget estimate for the main handling equipment

<u>Equipment</u>	<u>Capacity</u>	<u>Budget (€) excl. VAT</u>
<p><u>Stacker</u></p> 	1,500 kg	€10,500 € - €17,500
<p><u>Forklift</u></p> 	1,500 kg	€22,000 - €31,000
<p><u>Reach stacker</u></p> 	45 T	€550,000 - €690,000 (leasing solutions are available)

Crane

Excluding base



2 T at 12 metres

€100,000 - €150,000

Crane truck



2 T at 12 metres

€180,000 - €240,000

Weighing platform

1,500 X 1,500 mm

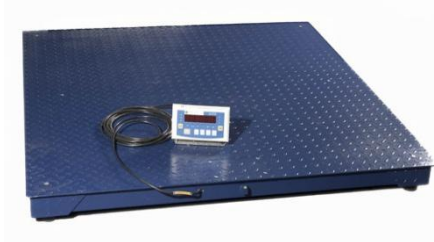

3,000 kg

€4,000 - €5,500

4. PHASE 3 - CONNECTING THE VERGOTE PLATFORM TO THE TIR CENTRE

4.1 Background and objectives

The siting of the Vergote transshipment platform opposite the TIR (International Road Transport) centre is an opportunity to promote use of the waterway for the TIR centre, especially as the Port of Brussels plans to encourage innovative city distribution solutions based on the Vergote platform and the TIR centre in particular. Against this backdrop, it is vital to put in place a system to enable goods to cross Avenue du Port safely and securely.

4.2 Possible solutions

There are five theoretically possible solutions for crossing Avenue du Port:

1. A tunnel through which trolleys/carts would be conveyed;
2. A footbridge over which trolleys/carts would be conveyed;
3. A lift connected to a bridge with a conveyor belt;
4. A cable-based transport system;
5. Conveying trolleys/carts across the (suitably reconfigured) road.



Figure 61: Illustrations of the five theoretically possible solutions (source: Technum)

4.3 Choosing the best solution

An analysis was performed to select the most appropriate solution(s). The following table summarizes the advantages and disadvantages of each potential solution:

	Trolleys/carts via tunnel	Trolleys/carts via footbridge	Transport by cable	Lift & bridge with conveyor belt	Trolleys/carts via road
Technical constraints					
Utility networks affected (cables, pipes, etc.)	-	+	+	+	+
Footprint	- Long ramps	- Long ramps	+	+	+
Safety constraint	+	+	- Dual resistance (below and above)	+	- (road safety)
Operating constraints					
Separation of traffic on Avenue du Port	+	+	+	+	- Traffic lights & road surface
Maximum load per unit	8 T	8 T	1.5 T	1.5 T	8 T
Compatible with pallets & big bags	+	+	+	+	+
Flexibility of load on each crossing	+	+	-	-	+
	Trolley convoy	Trolley convoy		big-bag rack	Trolley convoy
Capital cost	--	--	+	+	++

Figure 62: Advantages and disadvantages of the five solutions (source: Technum)

The tunnel and footbridge options were eliminated straight away due to the significant capital cost and the footprint they would occupy (ramps taking up a large surface area).

The chosen solution, at least for the time being, is to convey trolleys/carts at road level or using a crane truck on the road network, owing to its efficiency, flexibility and low cost. It is also the best alternative in terms of fitting in with the built environment and cityscape of Avenue du Port.

This means that the crossing of Avenue du Port (30 metres) will have to be controlled by installing traffic lights. The Avenue du Port redevelopment scheme is an opportunity to install such a crossing system and to adapt the road surface (replacing the cobblestones with a concrete surface) at the crossing point.

If traffic between the platform and the TIR centre were to increase very significantly, it may become appropriate to develop the solution involving a lift connected to a bridge with a conveyor belt. That way, handling activities would be kept completely separate from road traffic. This system could be directly connected to the upper level of the TIR centre, meaning that a lift would not be required on the TIR centre side. However, the cost of such a set-up would remain substantial, as would its potential impact on the Avenue du Port cityscape.

5. PHASE 4 – LAYOUT, OPERATIONAL AND TRAFFIC PLANS

5.1 Summary of the operational programme

An operational programme has been drawn up based on the foregoing analyses and the discussions with Port of Brussels representatives.

This programme can be summarised as follows:

Site	Vessel	Package types	Loading / unloading	Storage
Biestebroeck	Class I to Class IV (with or without on-board crane)	Containers Pallets Big bags Potentially other lightweight packaging (waste bales, etc.)	From the vessel (on-board crane) and from the quay using one mobile machine (reach stacker for containers, forklift and/or crane truck for pallets)	Limited, mainly cross-docking Covered storage covering around 1/3 of the surface area Possibility of installing storage racks
Vergote	Idem	Idem, but optional for containers (depending on costs and traffic forecasts)	Idem The crane truck is a particularly viable option for crossing Avenue du Port	Idem

Table 22: Summary of the operational programme (source: Technum)

5.2 Biestebroeck

The layout of the Biestebroeck platform is shown on Map 3.

Essentially, it includes:

- four mooring dolphins (indicative diameter: 1 m), whose outer edge is situated 4.5 m from the current quayside;
- a reinforced platform measuring 25 m x approx. 33.7 m (843 m²), resting on a frame of piles (see Map 4). These dimensions are big enough to allow reach-stacker manoeuvring, storage and the loading of a small number of containers;
- a flexible traffic and handling area (559 m²);
- a storage area for pallets and big bags (or empty or unstacked containers) covering 578 m². This area provides 256 ground-level spaces for Euro-pallets. That figure can be increased by stacking the pallets;
- outside the reinforced area, the quayside will not be able to accommodate heavy loads (as per the results of Phase 2).

Vehicles could enter the platform from Digue du Canal (north side) and exit it onto the same road (south side). This would mean that no reversing or left-turning would be necessary (see Maps 3 and 6). Exit from the platform would be via the neighbouring plot, which is currently unoccupied and belongs to the Port of Brussels.

As regards navigation and moorings, it should be noted that the Petite Île bridge is due to be replaced, which will remove the bottleneck at that point. Interactions with the neighbouring berth (used to store petroleum products) are illustrated on Map 5.

5.3 Vergote

The layout of the Vergote platform is shown on Map 9.

Essentially, it includes:

- four mooring dolphins (indicative diameter: 1 m), whose outer edge is situated 3.7 m from the current quayside;
- a reinforced platform measuring 25 m x 25 m (625 m²), resting on a frame of piles (see Map 13). These dimensions are big enough to allow reach-stacker manoeuvring (if a reach stacker is used), storage and the loading of a small number of containers;
- a flexible traffic and handling area (1,662 m²);
- a storage area for pallets and big bags (or empty or unstacked containers) covering 1,887 m². This area provides 656 ground-level spaces for Euro-pallets. That figure can be increased by stacking the pallets;
- outside the reinforced area, the quayside will not be able to accommodate heavy loads (as per the results of Phase 2).

Entry to the platform will be via Avenue du Port. These entrances, as well as the crossing to the TIR centre, will need to be incorporated into the general redevelopment scheme for Avenue du Port, currently under consideration by Bruxelles Mobilité (road public agency).

As regards navigation and moorings, accessing the platform poses no particular problems and there are no other berths in the immediate vicinity.

A number of different options for reinforcing the platform were also considered (see Phase 2 and Maps 10 to 16). These do not fundamentally affect the basic layout.

5.4 Other work and equipment

The main cost item for the project relates to the reinforced slabs for shoring up the existing quay walls, which are not currently strong enough. The cost of producing these slabs has been estimated at €1,450,000 for Biestebroek and between €1,650,000 and €1,000,000 for Vergote (depending on which option is chosen). See 3.1.5.2. and 3.1.5.3.

Handling equipment may also represent a significant cost item. This equipment has been described above (see respectively 3.1.5 and 3.3.7, 3.3.7). However, these costs can be shared between developers and operators.

Other infrastructure/equipment must also be provided, and studied in greater detail where necessary:

- At Biestebroek, the site needs to be decontaminated before work can begin. Plans to carry out this decontamination have already been submitted to the relevant authority (Bruxelles Environnement), and the recommendations arising from the soil pollution studies have been incorporated into our proposal (limiting the excavation depth, not draining the bottom of the excavation).
- At Vergote, the old crane present on the site will have to be dismantled and scrapped (or moved to another location where it can be preserved as a heritage item).
- The connection with existing roads, and, in the case of Vergote, the crossing of Avenue du Port. However, the creation of the new entrance to the platform and the crossing over the Avenue should be incorporated into the general redevelopment scheme for Avenue du Port. Consequently, the marginal cost of road modifications generated by the project will be small.
- Connections to utility networks (electricity, drinking water, rainwater). As regards drainage, water can either be released into the sewer system or by gravity into the canal, installing a valve and buffer tank in case of spillage.
- Lighting: in order to ensure sufficient operating timeframes, it is recommended that basic lighting be installed on the platforms.
- Reception and operations room: this could take the form of a pre-fab (site container).
- Security facilities: the installation of (meshed) fencing and gates is recommended.
- It is recommended that around 1/3 of the storage area be covered, in order to house moisture-sensitive products (Gyproc, etc.).

- It might also be worth installing storage racks, although this is not necessary for operations to begin.
- IT equipment: suitable IT equipment will be required to keep track of packages and organise the storage.

5.5 Evaluation of operational performance

5.5.1 Transfer time (entry/exit)

Based on the information obtained from the surveys of port operators carried out for this study, we can assume the following times for the various transfers involved:

➤ Vessel <-> Quay:

- Four hours is enough time to (un)load 198 pallets onto/off a vessel.
- It takes two machines five hours to (un)load 500 pallets onto/off a vessel.

This equates to an average of 50 pallets per hour and per handling machine.

➤ Quay <-> Truck (or storage area):

- Given the distance involved, just under 60 pallets can be moved comfortably in one hour.

➤ Truck transit – (un)loading:

According to the trailer loading plan, 18 to 22 pallets can be transported on each journey of a semi-trailer truck.

5.5.2 Goods storage and waiting time

A number of factors have to be considered when transshipment of packages involves temporary storage.

A range of goods in a stock is always made up of different items with different turnover times, as some products are more in demand than others.

The turnover rate is a key factor in determining the layout of the storage area, and of the picking area and buffer area where present.

Depending on the customers and recipients concerned, the relative importance of the storage locations must be determined: these can be fixed or random positions and sometimes even a combination of the two.

To limit and ensure optimum management of logistics costs, queuing should be avoided.



Figure 63: Current configuration of Digue du Canal where it passes under Petite Île bridge (source: Technum)

The regional authorities also plan to create a roundabout at the end of the Petite Île bridge, which would facilitate all movements from/to the platform and make it easy for vehicles to turn around. However, the plan also involves introducing one-way traffic into and out of the roundabout, which will have a bearing on the platform's accessibility.

The following map shows the preferred access routes, taking into account the regional authorities' plans:

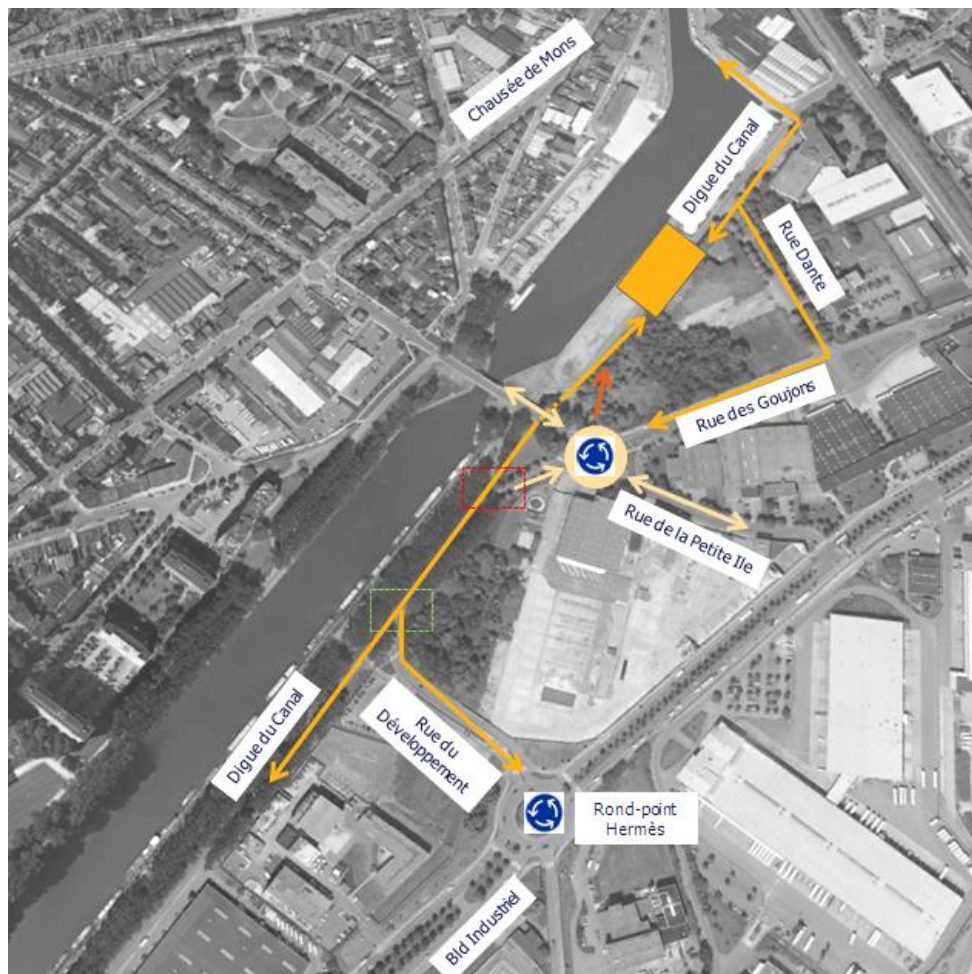

Figure 64: Access to the Biestebroek platform (source: Technum)

In summary, vehicles can enter and leave the platform via either of the following routes:

1. Digue du Canal from/to the south-west passing under the Petite Île bridge, via Rue du Développement and the Rond-point Hermès roundabout.

It should be noted that the configuration of the junction where Digue du Canal meets the one-way street joining the new roundabout (red box) is such that trucks coming from the platform would not be able to turn left at this point. They would therefore have to continue along Digue du Canal and then turn into Rue du Développement. The junction between these two streets (green box) does allow trucks to turn left.



Figure 65: Configuration of the junctions near to the Biestebroeck platform (source: Technum)

2. Digue du Canal from/to the north, joining Rue des Goujons and the new roundabout via Rue Dante or carrying on towards Chaussée de Mons.

To reach the platform, vehicles can also use the one-way section of Digue du Canal from the new roundabout.

All of the roads on these preferred routes are suitable for heavy goods vehicles.

The additional traffic (14 PCE per hour, in the most extreme scenario) generated by the platform's activities, which would spread out onto the road network, is not significant compared with the existing traffic (minimum of 115 PCE/hour on the roads surrounding the platform).

5.6.3 Vergote platform

The layout of the Vergote transshipment platform requires a new junction to be built to give access to the platform. Vehicles will exit the platform via the existing junction, which is already used by vehicles entering and leaving the premises of Mpro. This junction, which is currently governed by a 'Give Way' sign, will in future require a set of traffic lights to enable trolleys/carts and crane trucks to cross safely.

Given the number of junctions in the vicinity (five in the space of some 500 m), it is recommended that the planned traffic-light junctions be operated in a coordinated way. The junctions in question are the platform exit, the possible new access junction to T&T for which T&T has submitted planning permission, and the existing junction with Pont des Armateurs bridge. The lights at the exit from the platform/Mpro might only be activated upon request, which would limit the impact on traffic in Avenue du Port.

The analysis of the capacity of the junction between the TIR centre, platform and Mpro is based on a) infrastructure supply, represented by the road layout and the type of traffic control at the junction, and b) traffic demand, represented by traffic flows at the junction. We therefore base our analysis on the following three parameters:

1. Road layout as shown below.

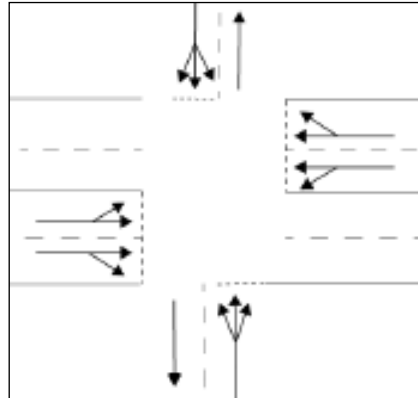

This layout (2x2 lanes on Avenue du Port) is as per the Avenue du Port redevelopment scheme.

Indeed, the office of Brussels transport minister Brigitte Grouwels confirmed to us that, following a rejection of the plans submitted in 2011, a new scheme to redevelop Avenue du Port has recently been registered, with the following main features:

- Keep the rows of trees
 - Keep the recently renovated pavement on the outside of the road
 - Create cycle lanes under the trees, on the inside of the road
 - Alter the layout of the road to a 2x2 lane system
 - Prohibit parking
 - Keep the same junction control systems.
2. Traffic lights to control the junction. This does not fit with the Avenue du Port redevelopment scheme but is necessary to enable trolleys/carts to cross Avenue du Port.
 3. Traffic distribution at this junction. This includes the traffic flows currently using Avenue du Port and generated by Mpro as well as the traffic flows from the TACT project (expansion of the TIR centre) and the forecast flows resulting from the activities of the future transshipment platform.

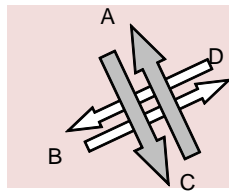

- Branche A** Av. Du Port (nord)
- Branche B** centre TIR
- Branche C** Av. Du Port (sud)
- Branche D** plateforme multiusage

Heure de pointe du soir (17h00-18h00)

Matrice d'intensité du trafic		A	B	C	D	
A	0	6	410	15	431	
B	13	0	35	0	48	
C	1461	13	0	45	1519	
D	15	0	45	0	60	
	1489	19	490	60	2058	

The following table summarises congestion levels at the junction.

	R_{en} par direction			X_{en} par direction			X_{en} par bande			D_{en} par bande		
	R	RD	L	R	RD	L	R	RD	L	R	RD	L
Branche A	1307	2680	192	0%	13%	7%	0%	21%	0%	0,0	1,5	0,0
Branche B	54	0	86	39%	0%	13%	0%	52%	0%	0,0	54,9	0,0
Branche C	1268	1629	895	3%	47%	1%	0%	52%	0%	0,0	2,2	0,0
Branche D	74	0	51	17%	0%	47%	0%	63%	0%	0,0	55,2	0,0

- R_{en} capacité restante (nbre de véhicules)
- X_{en} Taux de congestion (%)
- D_{en} Temps d'attente moyen (sec/veh)

At the exit from the platform (branch D of the junction), just 63% of capacity is used (the other branches use even less capacity). The average waiting time is around 55 seconds for vehicles exiting the platform/Mpro.

Although such saturation is not caused by port activities, it should be noted that this junction configuration would reach saturation in the event of full development of the whole Tour & Taxi area and nearby projects (Tivoli, etc.). The solution then would be to create a 3 x 3 lane layout on Avenue du Port (with a dedicated lane for vehicles turning left; one lane for vehicles going straight on; and one for vehicles going straight on and turning right). However, this solution does not seem feasible given that cycle lanes will be created following the prohibition of parking.

It will be noted that the recently registered Avenue du Port redevelopment scheme does not include traffic lights at the junction with the platform exit/Mpro entrance and exit, which is controlled by a 'Give Way' sign. Nor does the scheme include a new junction at the entrance to the transshipment platform.

Map 18 (cf. annex) illustrates the layout to be implemented at the platform exit junction.

6. CONCLUSION

This study firstly identified the needs of the potential users of both the Biestebroeck and Vergote platforms. An international benchmarking exercise, analyses and contacts made during the study confirmed that the main market segment is waterway transport of construction material pallets. The public authorities and a number of logistics operators and businesses are currently engaged in developing projects, although no single concept has so far emerged. Against this backdrop, it seems important that the two planned platforms at the Port of Brussels maintain maximum flexibility and remain independent of the logistics solutions of the various operators, in accordance with the Port's desire to provide a multi-service/multi-client offering.

The technical implications of the scheme were then examined. The key elements relate to structural reinforcements of the historic quay walls, to allow them to accommodate the goods in question in sound operational conditions. The costs associated with the quay reinforcement work are sizeable, irrespective of the operational programme (containers or no containers) and the planned dimensions.

Layout and operational plans for the two platforms were proposed, incorporating the various elements highlighted during the study. These confirmed that, despite the limited size of the sites (particularly Biestebroeck), it is possible to come up with an effective design that meets the needs of the likely users.

Lastly, it seems that the intrinsic impact of the two platforms on road traffic would be negligible. The crossing over Avenue du Port to the TIR centre should ideally be incorporated into the general redevelopment scheme for the Avenue.

7. BIBLIOGRAPHY

- « Recommendations of the Committee for Waterfront Structures Harbours and Waterways ». EAU, 2004.
- « Report of the PIANC Working Group II-9, Development of modern Marine Terminals ». Supplement to PIANC-Bulletin No 546, Brussels 1987. PIANC, 1987.
- "Recommendations for the application of Eurocode 7 in Belgium. Part 1: Geotechnical design in ultimate limit state of axial loaded piles". WTCB, 2008.
- « Nieuw kraanschip voor palletvervoer ». Magazine Binnenvaart #61 Mei 2013.
- « Kade voor bouwmaterialen in Rumst ». Magazine Binnenvaart #59 December 2012.
- « Transport des déchets, la solution fluviale ». Plaquette ADEME, VNF.
- « Etude de la faisabilité économique d'un report modal des FMCG palettisés sur les voies navigables ». Rapport final, mai 2013. Vrije Universiteit Brussel (VUB).
- « Port de la Bourdonnais – Paris 7^{ème}. Réaménagement d'un port urbain dans le cadre de la création d'une activité de logistique urbaine ». Ports de Paris. CCP 21. 31 janvier 2013.
- « Franprix entre en Seine ». Communiqué de presse du 16 mars 2012. Franprix.
- « VNF accompagne la livraison fluviale du cœur des villes ». Communiqué de presse du 1^{er} octobre 2012. VNF.
- « Projectdefinitie Blue Gate Antwerp ». Bijlage 1 bij de selectieleidraad Blue Gate Antwerp. BlueGate Antwerp NV.
- « Dossier fluvial ». Journal de la marine marchande, décembre 2012.
- « Construction d'un nouveau pont. Aménagement des berges du canal. Commune d'Anderlecht. Quartier de la Petite Ile. » Présentation en réunion de concertation du 21 octobre 2009.
- « Pallet Shuttle Barge Network. Logistiek Systeem voor Goederen op Pallet of in Big Bag met flexibele & gespecialiseerde binnenvaart ». Présentation de Blue Line Logistics.
- « Knauf - Politique de transport & Stratégie de diversification ». Présentation à la journée du transport fluvial du 19 juin 2013.
- « Etude de l'installation d'un bras de manutention dans une cale Freycinet existante pour la manutention de différents types de marchandises ». Cabinet Lebéfaude pour VNF. Mai 2011.

8. ANNEX

- Annex 1: Maps folder
 - Map 1: Biestebroeck platform – current situation
 - Map 2: Biestebroeck platform – localization
 - Map 3: Biestebroeck platform – layout, operational and traffic plans
 - Map 4: Biestebroeck platform – strengthening proposal
 - Map 5: Biestebroeck platform – Interactions with the neighbouring berth
 - Map 6: Biestebroeck platform – check of the truck movement
 - Map 7: Vergote platform – current situation
 - Map 8: Vergote platform – localization
 - Map 9: Vergote platform – layout, operational and traffic plans (reinforced platform – 6 T/m² mobile load, 25m x 25m)
 - Map 10: Vergote platform – layout, operational and traffic plans (reinforced platform – 4 T/m² mobile load, 25m x 25m)
 - Map 11: Vergote platform – layout, operational and traffic plans (reinforced platform – 4 T/m² mobile load, 25m x 20,5m)
 - Map 12: Vergote platform – layout, operational and traffic plans (reinforced platform – 4 T/m² mobile load, 25m x 16m)
 - Map 13: Vergote platform – strengthening proposal (reinforced platform – 6 T/m² mobile load, 25m x 25m)
 - Map 14: Vergote platform – strengthening proposal (reinforced platform – 4 T/m² mobile load, 25m x 25m)
 - Map 15: Vergote platform – strengthening proposal (reinforced platform – 4 T/m² mobile load, 25m x 20,5m)
 - Map 16: Vergote platform – strengthening proposal (reinforced platform – 4 T/m² mobile load, 25m x 16m)
 - Map 17: potential clients' localization
 - Map 18: layout for the platform exit junction

- Annex 2: CPT – Biestebroeck Dock
- Annex 3: CPT – Vergote Dock
- Annex 4: Pile resistance - Biestebroeck Dock
- Annex 5: Pile resistance - Vergote Dock
- Annex 6: Minutes of the meetings done during the study:
 - Interview with Carl Verhamme (logistic expert of the Port of Brussels)
 - Interview with VUB (carrying out the study about modal shift of FMCG (Fast Moving Consumer Goods) on pallets to fluvial transport)
 - Interview with INBEV
 - Interview with Ship It
 - Interview with Jo Go Shipping
 - Interview with M-Pro
 - Interview with construction material company n°1
 - Interview with construction material company n°2
 - Visit of « Mokum Mariteam » in Amsterdam

ANNEX 2
CPT – BIESTEBROECK DOCK

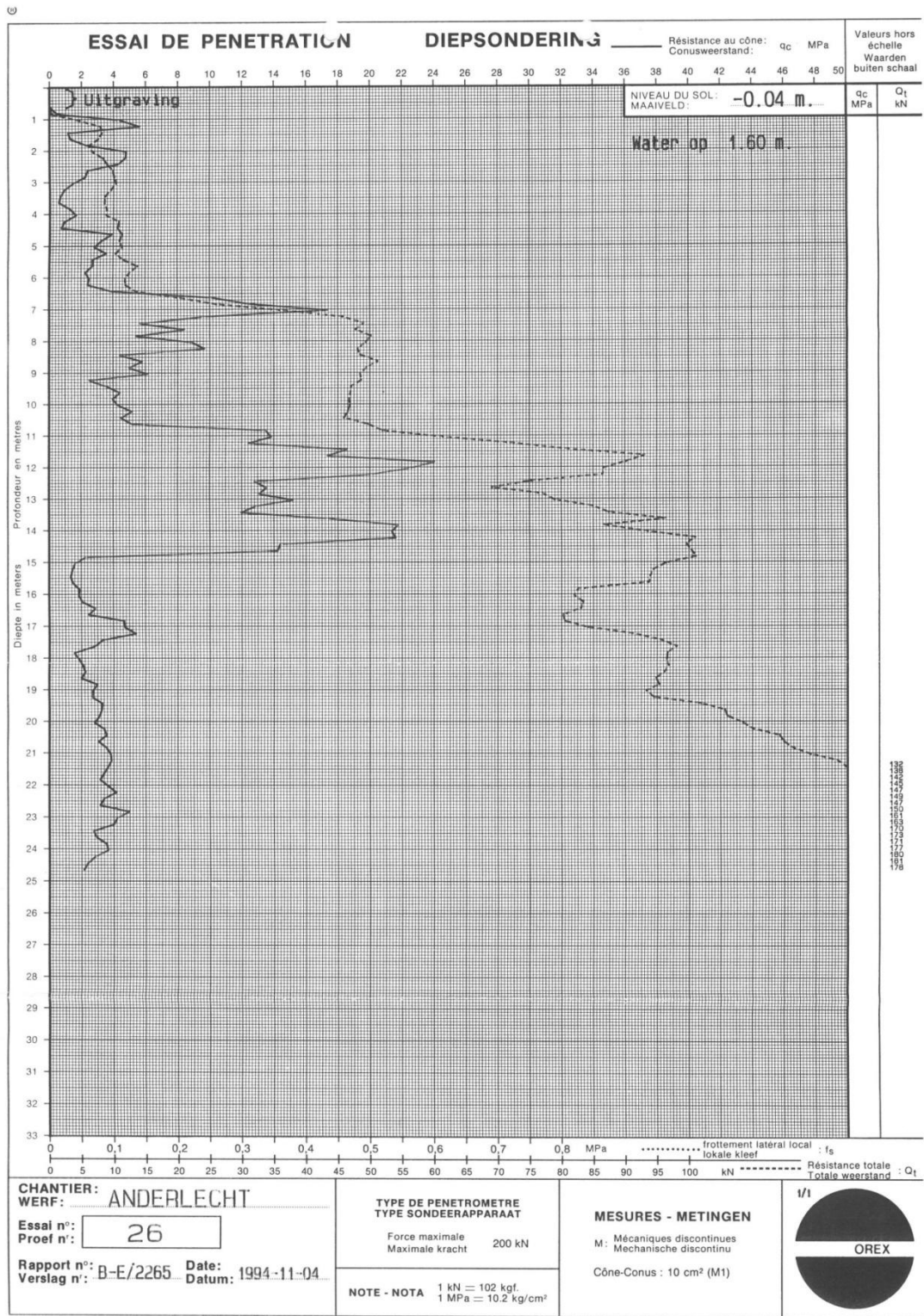



Proef volgens ISO 22476-1, toepassingklasse 2, proef type TE1

B48714 - S01a
Uitvoeringsdatum: 03/07/2013
1000 Brussel

CPT-E 15 cm²
200 kN
GRW: Geen water

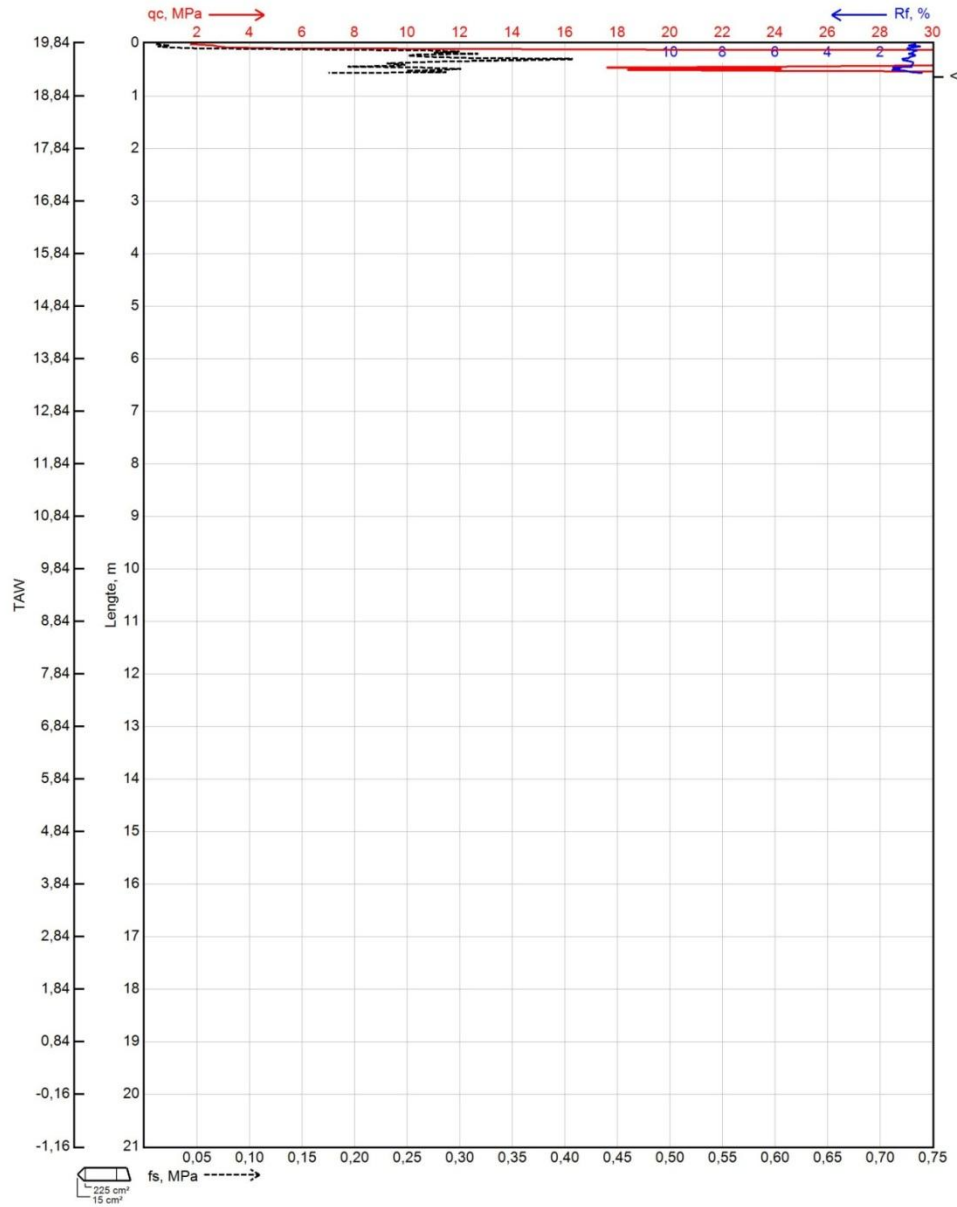

Bijlage D

Pagina 15 / 46 (v1)



Proef volgens ISO 22476-1, toepassingklasse 2, proef type TE1

B48714 - S01b
Uitvoeringsdatum: 03/07/2013
1000 Brussel

CPT-E 15 cm²
200 kN
GRW: Geen water

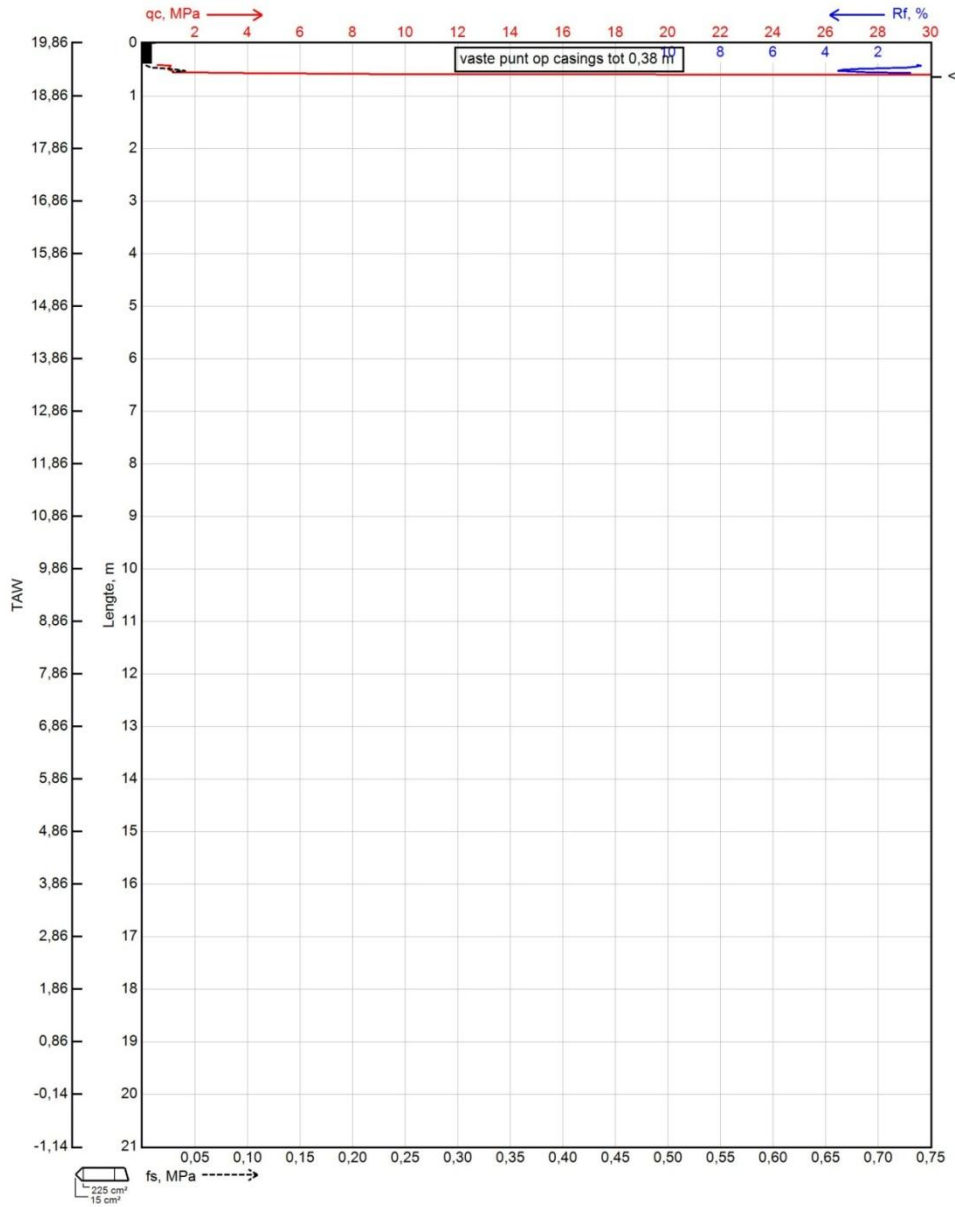

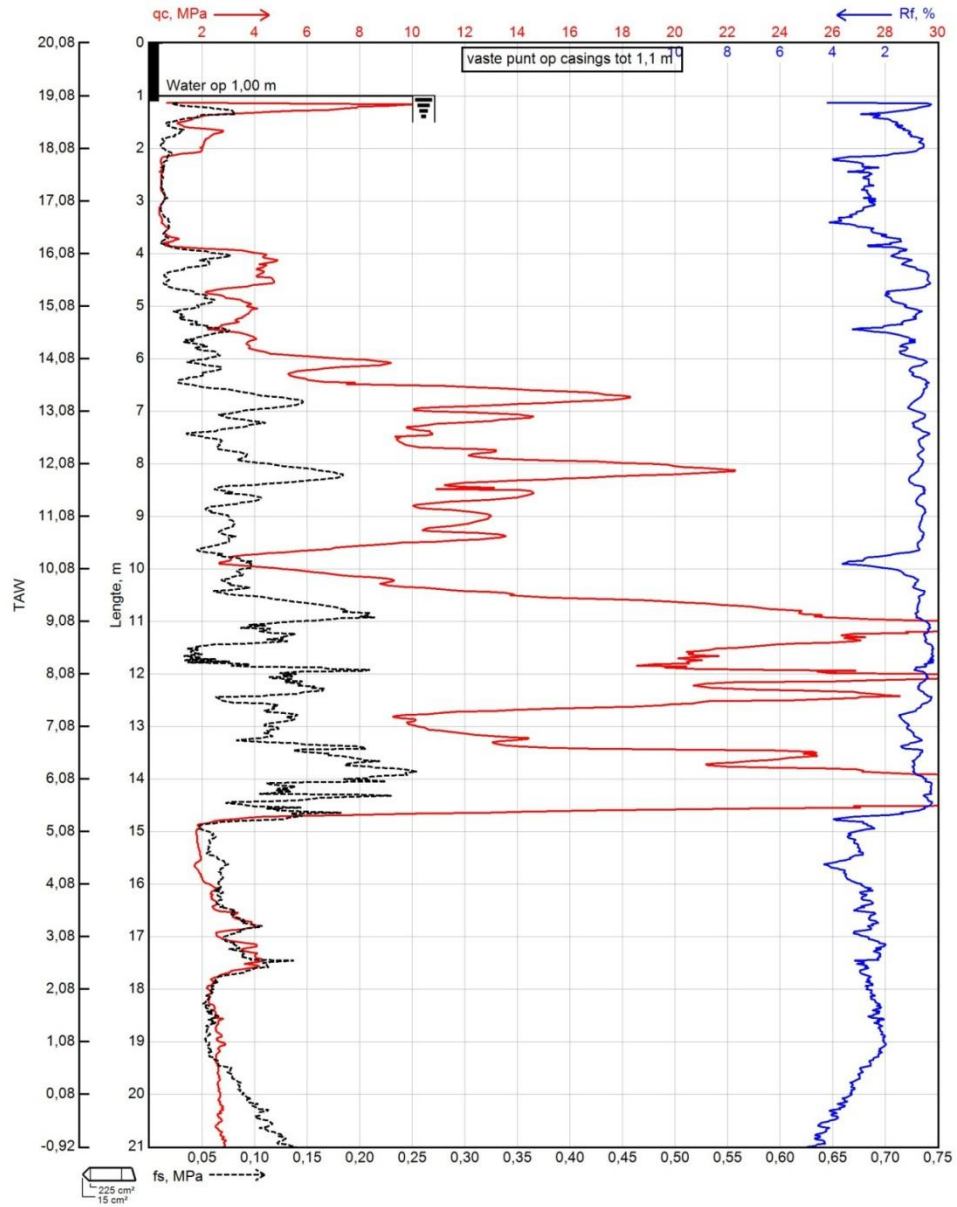



Proef volgens ISO 22476-1, toepassingklasse 2, proef type TE1

B48714 - S02
Uitvoeringsdatum: 03/07/2013
1000 Brussel

CPT-E 15 cm²
200 kN
GRW: Water op 1,00 m

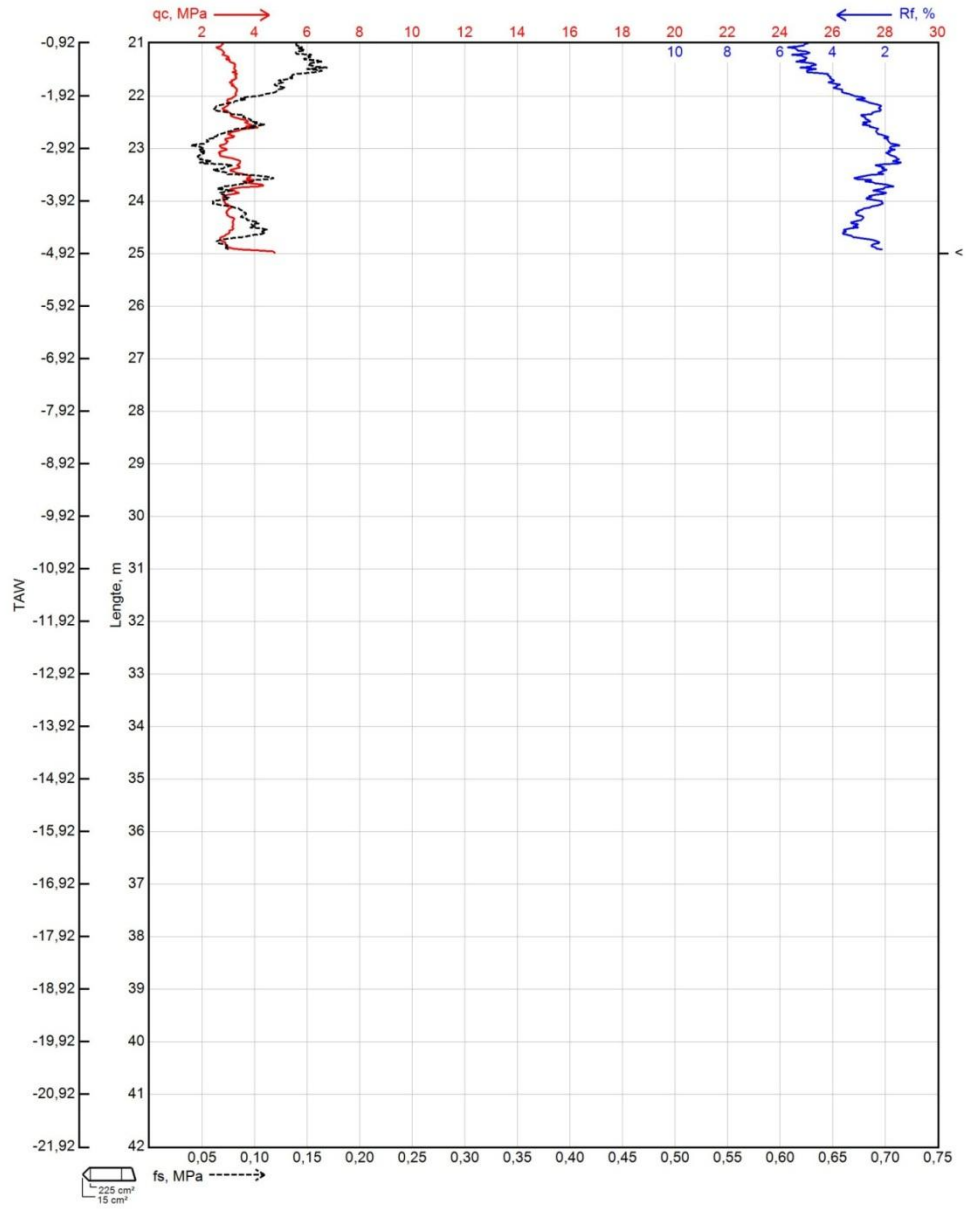

Bijlage D

Pagina 18 / 46 (v1)



Proef volgens ISO 22476-1, toepassingklasse 2, proef type TE1

B48714 - S03
Uitvoeringsdatum: 03/07/2013
1000 Brussel

CPT-E 15 cm²
200 kN
GRW: Droog dichtgevallen op 0,70 m

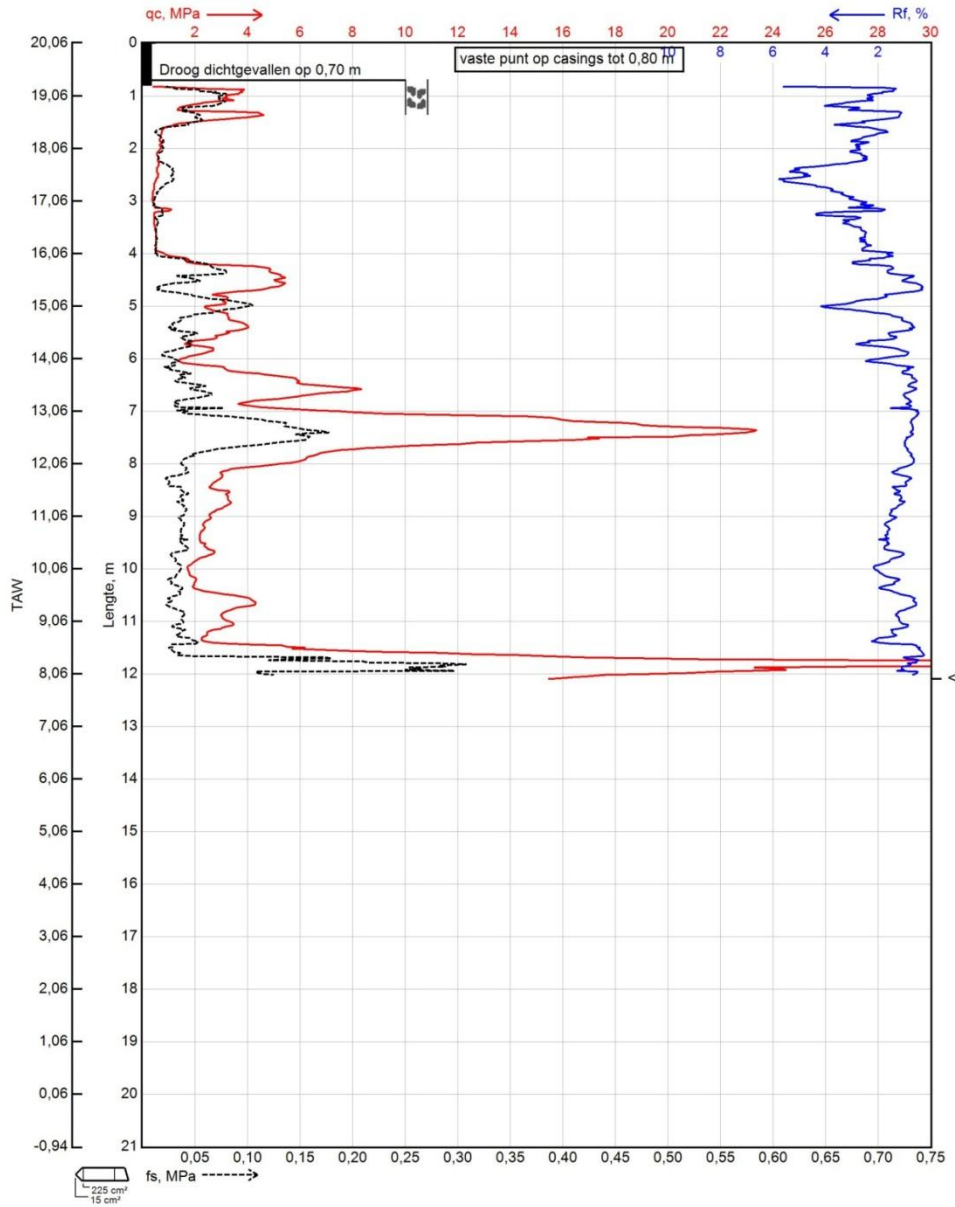

ANNEX 3

CPT – VERGOTE DOCK



Proef volgens ISO 22476-1, toepassingklasse 2, proef type TE1

B48714 - S05
 Uitvoeringsdatum: 03/07/2013
 1000 Brussel

CPT-E 15 cm²
 200 kN
 GRW: Water op 1,05 m

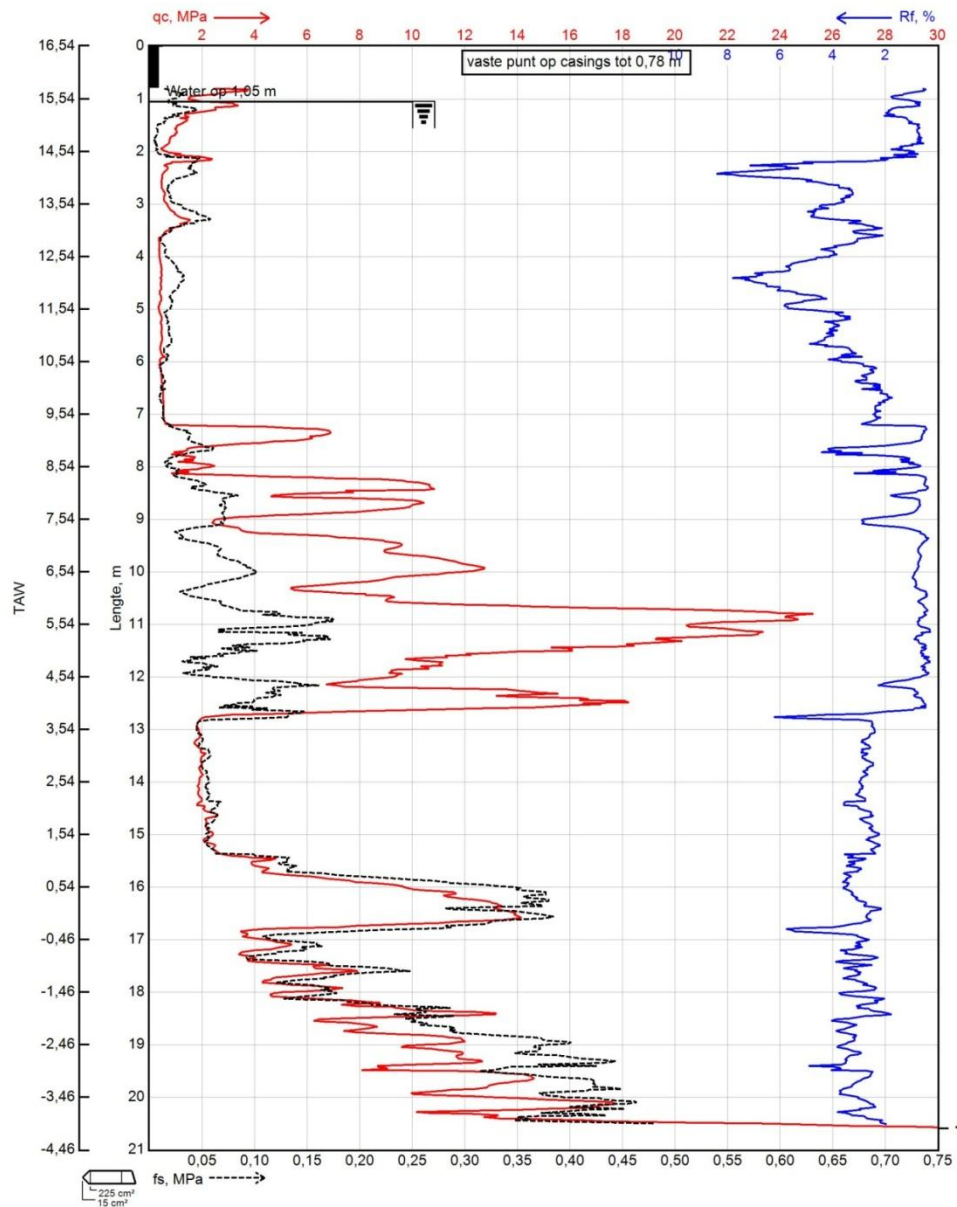

Bijlage D

Pagina 20 / 46 (v1)



Proef volgens ISO 22476-1, toepassingklasse 2, proef type TE1

B48714 - S06
Uitvoeringsdatum: 03/07/2013
1000 Brussel

CPT-E 15 cm²
200 kN
GRW: Water op 0,70 m

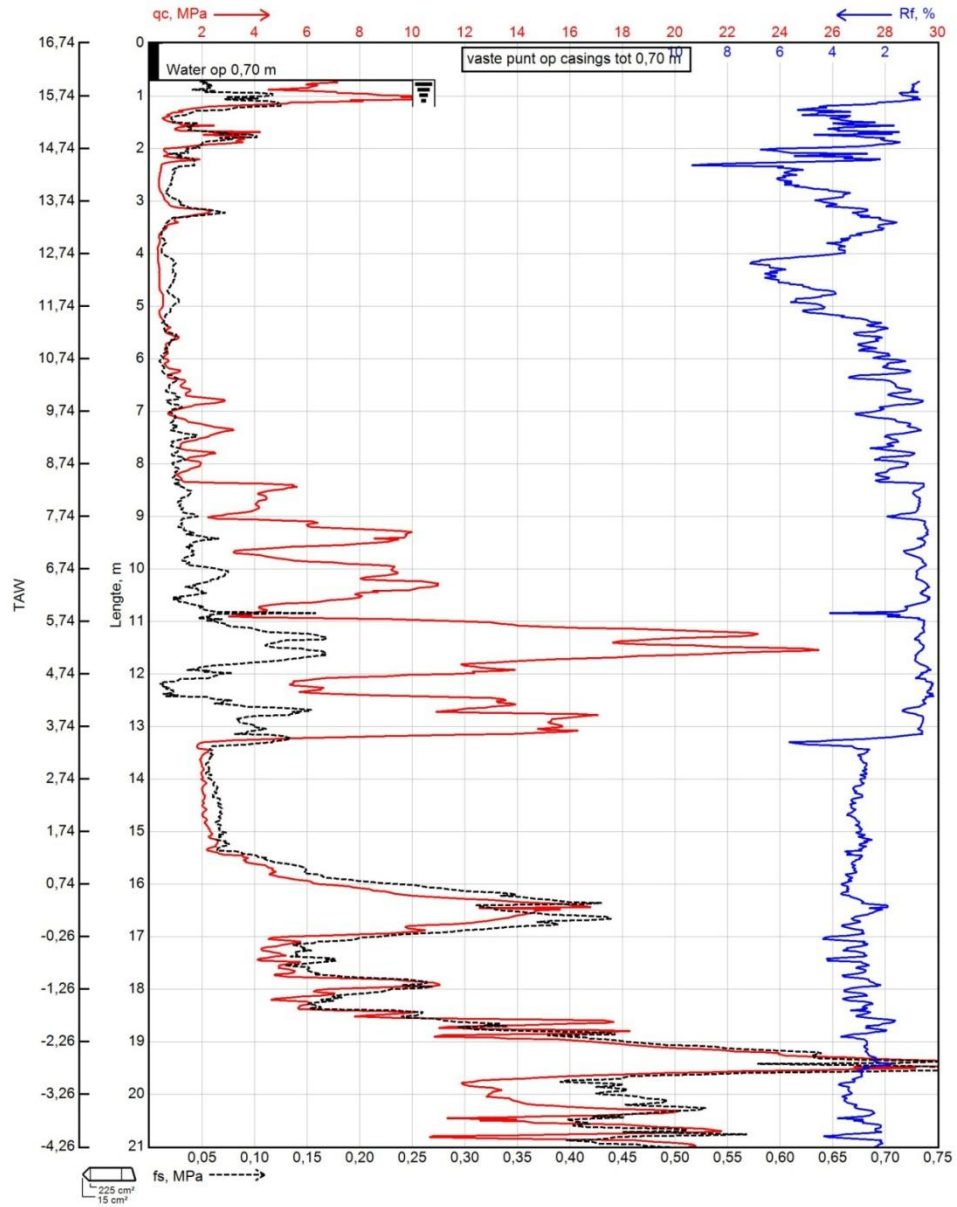

Bijlage D

Pagina 21 / 46 (v1)



Proef volgens ISO 22476-1, toepassingklasse 2, proef type TE1

B48714 - S06
Uitvoeringsdatum: 03/07/2013
1000 Brussel

CPT-E 15 cm²
200 kN
GRW: Water op 0,70 m

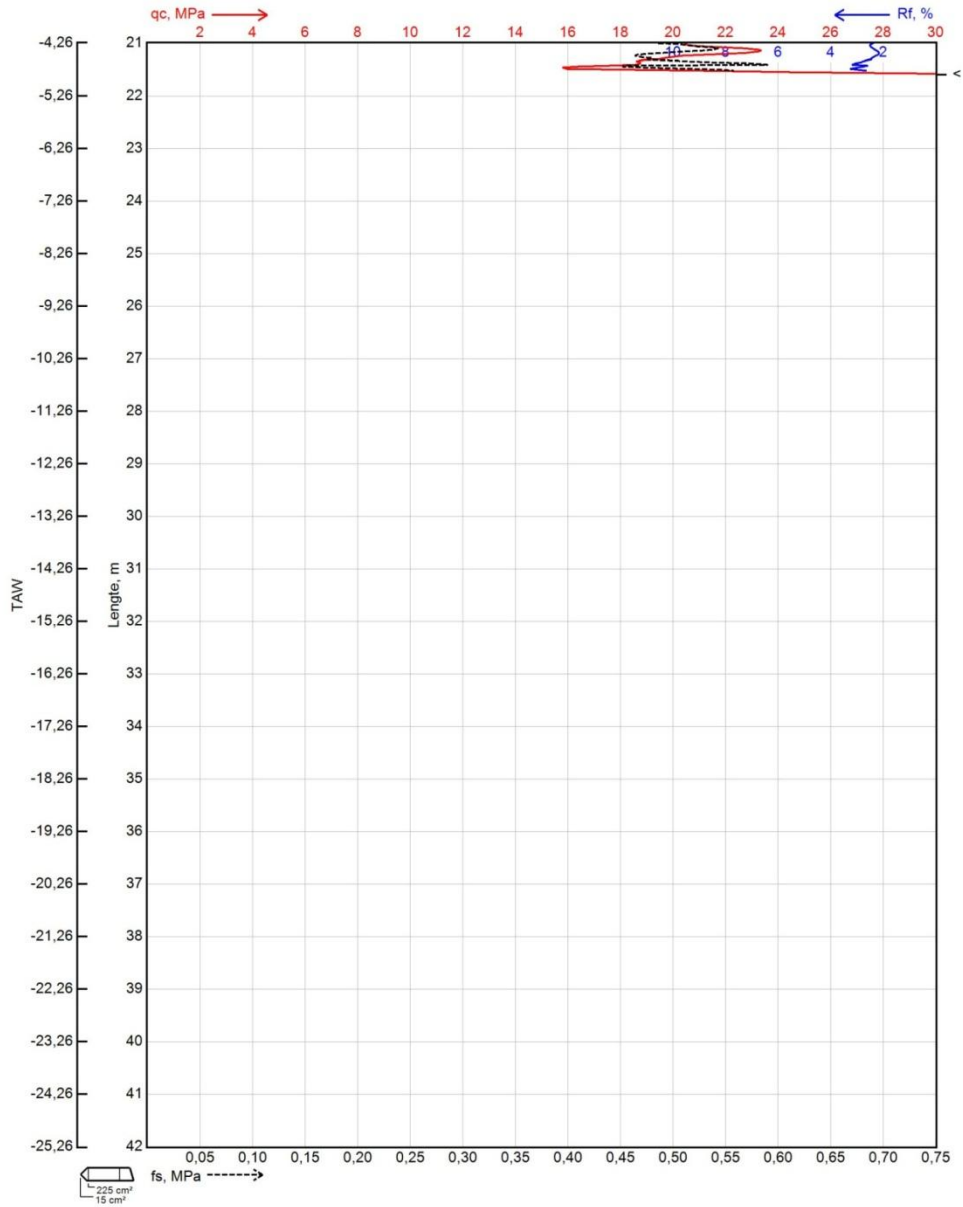

Bijlage D

Pagina 22 / 46 (v1)

ANNEX 4

PILE RESISTANCE – BIESTEBROECK DOCK

Draagvermogen volgens rekenmethode werkgroep WTCB (versie maart. 2007) :
Gebaseerd op De Beer en partiële veiligheidscoëfficiënten EC7

Paaldiameter	0.30 m	conversiefactor CPT-conus	$\omega =$	1 tertiaire klei
Diameter conus D_c	0.036 m		$\omega =$	1 geen tertiaire klei
v. diameter paalpunt $D_{b,eq}$	0.339 m (*)	vormfactor	$\beta =$	1.0000
sectie punt A_b	0.090 m ²	installatiecoëff. punt	$\alpha_b =$	1 tertiaire klei
wrijvingsomtrek γ_s	1.200 m		$\alpha_b =$	1 geen tertiaire klei
		installatiecoëff. wrijving	$\alpha_s =$	0.9 tertiaire klei
aantal sonderingen	2		$\alpha_s =$	1 geen tertiaire klei
aanzetpeil	7.00 m TAW	reductie verbrede paalbasis	$\lambda =$	1
werkvlak	18.00 m TAW			
paallengte	11.00 m	Modelfactor	$\gamma_{Rd} =$	1.00
		Correlatiefactor	$\xi_3 =$	1.17
		Correlatiefactor	$\xi_4 =$	1.06
		Veiligheidscoëff. op punt	$\gamma_b =$	1.35
		Veiligheidscoëff. op wrijving	$\gamma_s =$	1.35 Druk
		Veiligheidscoëff. op wrijving	$\gamma_s =$	1.25 Trek
sondering		S1	S2	
aanzetpeil	m TAW	7	7	
$R_{c,cal}/\xi_3$	kN	1740	1348	
$R_{c,cal}/\xi_4$	kN	1920	1488	
$R_{b,cal}/\xi_3$	kN	746	746	
$R_{b,cal}/\xi_4$	kN	824	824	
$R_{s,cal}/\xi_3$	kN	994	602	
$R_{s,cal}/\xi_4$	kN	1097	664	
$(R_{c,cal}/\xi_3)_{gem}$	kN	1544.0		
$(R_{c,cal}/\xi_4)_{min}$	kN	1488.0	S3	
$R_{c,k}$	kN	1488.0	S3	
$(R_{b,cal}/\xi_3)_{gem}$	kN	823.8		
$(R_{b,cal}/\xi_4)_{min}$	kN	823.8	S2	
$R_{b,k}$	kN	823.8	S2	
$(R_{s,cal}/\xi_3)_{gem}$	kN	797.6		
$(R_{s,cal}/\xi_4)_{min}$	kN	664.2	S3	
$R_{s,k}$	kN	664.2	S3	
$R_{c,d, druk}$	kN	1102.2		
$R_{c,d, trek}$	kN	1141.6		

ANNEX 5

PILE RESISTANCE – VERGOTE DOCK

Draagvermogen volgens rekenmethode werkgroep WTCB (versie maart. 2007) :
Gebaseerd op De Beer en partiële veiligheidscoëfficiënten EC7

Paaldiameter	0.25 m	conversiefactor CPT-conus		$\omega =$	1	tertiaire klei
Diameter conus D_c	0.036 m			$\omega =$	1	geen tertiaire klei
v.diameter paalpunt $D_{b,eq}$	0.250 m (*)	vormfactor		$\beta =$	1.0000	
sectie punt A_b	0.049 m ²	installatiecoëff. punt		$\alpha_b =$	1	tertiaire klei
wrijvingsomtrek χ_s	0.785 m			$\alpha_b =$	1	geen tertiaire klei
		installatiecoëff. wrijving		$\alpha_s =$	0.9	tertiaire klei
aantal sonderingen	2			$\alpha_s =$	1	geen tertiaire klei
aanzetpeil	1.00 m TAW	reductie verbrede paalbasis		$\lambda =$	1	
werkvlak	11.00 m TAW					
paallengte	10.00 m	Modelfactor		$\gamma_{Rd} =$	1.00	
		Correlatiefactor		$\xi_3 =$	1.17	
		Correlatiefactor		$\xi_4 =$	1.06	
		Veiligheidscoëff. op punt		$\gamma_b =$	1.35	
		Veiligheidscoëff. op wrijving		$\gamma_s =$	1.35	Druk
		Veiligheidscoëff. op wrijving		$\gamma_s =$	1.25	Trek
sondering		S5	S6			
aanzetpeil	m TAW	7	7			
$R_{c,cal}/\xi_3$	kN	501	498			
$R_{c,cal}/\xi_4$	kN	553	550			
$R_{b,cal}/\xi_3$	kN	95	104			
$R_{b,cal}/\xi_4$	kN	105	115			
$R_{s,cal}/\xi_3$	kN	407	394			
$R_{s,cal}/\xi_4$	kN	449	435			
$(R_{c,cal}/\xi_3)_{gem}$	kN	499.8				
$(R_{c,cal}/\xi_4)_{min}$	kN	549.8	S6			
$R_{c,k}$	kN	499.8	average			
$(R_{b,cal}/\xi_3)_{gem}$	kN	109.7				
$(R_{b,cal}/\xi_4)_{min}$	kN	114.8	S6			
$R_{b,k}$	kN	109.7	average			
$(R_{s,cal}/\xi_3)_{gem}$	kN	400.4				
$(R_{s,cal}/\xi_4)_{min}$	kN	435.0	S6			
$R_{s,k}$	kN	400.4	average			
$R_{c,d, druk}$	kN	377.9				
$R_{c,d, trek}$	kN	401.6				

ANNEX 6
MINUTES OF THE MEETINGS DONE DURING THE
STUDY

